

JVC



MICRO COMPONENT SYSTEM

UX-G70

—Consists of CA-UXG70 and SP-UXG70

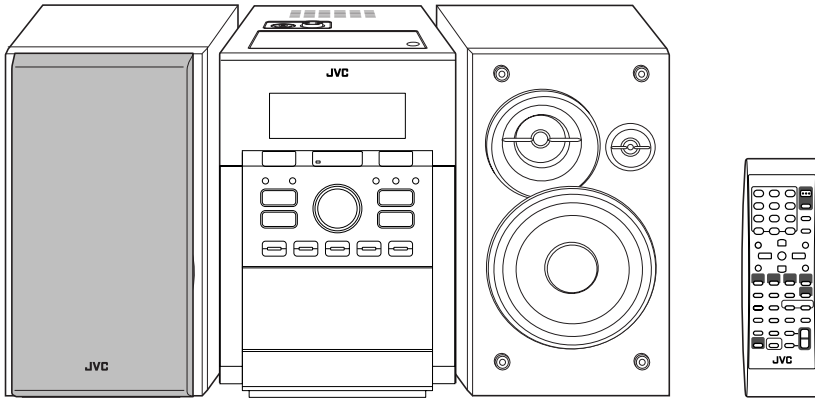

MP3/WMA
PLAY BACK

MPEG-4
ASF PLAYBACK

Digital Direct Progressive Scan

INSTRUCTIONS

Warnings, Cautions and Others

CAUTION— \odot /I (Standby/on) button!

Disconnect the mains plug to shut the power off completely (the STANDBY lamp goes off). When installing the apparatus, ensure that the plug is easily accessible. The \odot /I (Standby/on) button in any position does not disconnect the mains line.

- When the System is on standby, the STANDBY lamp lights red.
- When the System is turned on, the STANDBY lamp goes off.

The power can be remote controlled.

CAUTION

To reduce the risk of electrical shocks, fire, etc.:

1. Do not remove screws, covers or cabinet.
2. Do not expose this appliance to rain or moisture.

IMPORTANT FOR LASER PRODUCTS

1. CLASS 1 LASER PRODUCT

2. **CAUTION:** Do not open the top cover. There are no user serviceable parts inside the unit; leave all servicing to qualified service personnel.

3. **CAUTION:** Visible and/or invisible class 1M laser radiation when open. Do not view directly with optical instruments.

CAUTION

- Do not block the ventilation openings or holes.
(If the ventilation openings or holes are blocked by a newspaper or cloth, etc., the heat may not be able to get out.)
- Do not place any naked flame sources, such as lighted candles, on the apparatus.
- When discarding batteries, environmental problems must be considered and local rules or laws governing the disposal of these batteries must be followed strictly.
- Do not expose this apparatus to rain, moisture, dripping or splashing and that no objects filled with liquids, such as vases, shall be placed on the apparatus.

Caution: Proper Ventilation

To avoid risk of electric shock and fire, and to prevent damage, locate the apparatus as follows:

1. Front: No obstructions and open spacing.
2. Sides/ Top/ Back: No obstructions should be placed in the areas shown by the dimensions below.
3. Bottom: Place on the level surface. Maintain an adequate air path for ventilation by placing on a stand with a height of 10 cm or more.

Front view

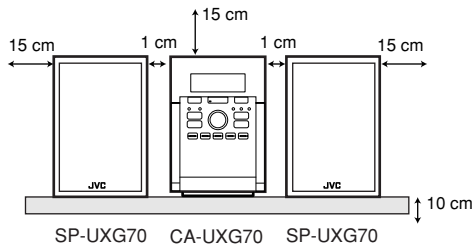

Side view

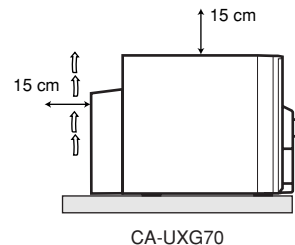

[European Union only]

Introduction

Precautions

Installation

- Install the System in a location with adequate ventilation to prevent internal heat buildup in the System.



DO NOT install the System in a location near heat sources, or in a place subject to direct sunlight, excessive dust or vibration.

- Install in a place which is level, dry and neither too hot nor too cold—between 5°C and 35°C.
- Leave sufficient distance between the System and the TV.
- Keep the speakers away from the TV to avoid interference with the TV.

Power sources

- When unplugging the System from the wall outlet, always pull on the plug, not the AC power cord.



DO NOT handle the AC power cord with wet hands.

Moisture condensation

Moisture may condense on the lenses inside the System in the following cases:

- After starting to heat the room
- In a damp room
- If the System is brought directly from a cold to a warm place.

Should this occur, the System may malfunction. In this case, leave the System turned on for a few hours until the moisture evaporates, unplug the AC power cord, then plug it in again.

Internal heat

- Make sure there is good ventilation around the unit. Poor ventilation could overheat and damage the unit.



DO NOT block the ventilation openings or holes. If they are blocked by a newspaper or cloth, etc., the heat may not be able to get out.

Others

- Should any metallic object or liquid fall into the System, unplug the AC power cord and consult your dealer before operating any further.



DO NOT disassemble the System since there are no user serviceable parts inside.

- If you are not going to operate the System for an extended period of time, unplug the AC power cord from the wall outlet.

If anything goes wrong, unplug the AC power cord and consult your dealer.

Contents

Connections	3
Display Indicators	6
Daily Operations—Playback	7
Daily Operations—Sound & Other Adjustments	13
Adjusting the Volume	13
Adjusting the Sound	13
Creating 3-dimensional Sound Field—3D Phonic	14
Presetting Automatic DVD Video Sound Increase Level	14
Adjusting the Audio Input Level	14
Adjusting the Audio Output Level	14
Changing the Display Brightness	15
Changing the Scanning Mode	15
Changing the Picture Tone	15
Setting the Clock	16
Turning Off the Power Automatically	16
Unique DVD/VCD Operations	17
Selecting the Audio Track	17
Selecting the Subtitle Language	18
Selecting the View Angle	18
Selecting the Browsable Still Pictures	18
Playing Back Bonus Group	18
Making Dialogues Clear—Clear Voice	19
Special Effect Playback	19
Advanced Disc Operations	20
Programming the Playing Order—Program Play	20
Playing at Random—Random Play	21
Playing Repeatedly	22
Prohibiting Disc Ejection—Child Lock	22
On-screen Disc Operations	23
Operations on the Control Screen	27
Advanced Tape Operations	29
Recording on a Tape	29
Synchronized Disc Recording	30
Enjoying Karaoke	31
Singing Along (Karaoke)	31
Microphone Mixing	32
Reserving Karaoke Songs—Karaoke Program Play	33
Timer Operations	34
Setup Menu Operations	36
Additional Information	38
Learning More about This System	38
Troubleshooting	41
Operating JVC's TVs Using the Remote Control	43
Specifications	44
Parts Index	45

Playable Disc Types

<ul style="list-style-type: none"> • CD-R/-RW: Recorded in the Audio CD, Video CD and SVCD formats. MP3, WMA, JPEG, MPEG-1, MPEG-2, ASF and DivX files written in accordance with the "ISO 9660" format can also be played. • DVD-R/-RW, +R/+RW: Recorded in the DVD Video format. MP3, WMA, JPEG, MPEG-1, MPEG-2, ASF and DivX files written in the UDF bridge format can also be played. • DVD-R/-RW/-ROM: Recorded in the DVD Video Recording (VR) format.

In addition to the above discs, this System can playback audio data recorded on CD-Extra.

The following discs cannot be played back: DVD-RAM, CD-I (CD-I Ready), CD-ROM, Photo CD, CD-G (CD-Graphics) and DVD/CD Text. Playing back these discs will generate noise and damage the speakers.

- In this manual, "file" and "track" are interchangeably used for MP3, WMA, JPEG, MPEG-1, MPEG-2, ASF and DivX operations.
- It is possible to playback finalized +R/+RW (DVD format only) discs. "DVD" lights on the front display panel when a +R/+RW disc is loaded.

About color system

This System accommodates the NTSC and PAL system and can playback discs recorded in either the NTSC or the PAL system.

- To change the color system, see page 15.

Note on Region Code

DVD players and DVDs have their own Region Code numbers. This System can playback only DVDs with an appropriate Region Code number.

For details, see "Specifications" on page 44.

EX.: For South East Asia



Audio formats

The System can playback the following digital audio formats.

- LPCM (Linear PCM), DIGITAL (Dolby Digital), DTS (Digital Theater Systems), MLP (Meridian Lossless Packing)

When playing a multi-channel encoded DVDs, the System properly converts these multi-channel signals into 2 channels, and emits the downmixed sound from the speakers.

- To enjoy the powerful sound of these multi-channel encoded DVDs, connect a proper decoder or an amplifier with a proper built-in decoder to the DVD OPTICAL DIGITAL OUT terminal on the rear.

IMPORTANT: Before playing a disc, make sure of the following...

- Turn on the TV and select an appropriate input mode on the TV to view the pictures or on-screen displays.
 - For disc playback, you can change the initial setting to your preference. See "Setup Menu Operations" on page 36.
- If "⊗" appears on the TV screen when you press a button, the disc cannot perform the operation you have tried to do.

How to Read This Manual

- Button and control operations are explained in the table below.
- Some related tips and notes are explained later in the sections "Learning More about This System" and "Troubleshooting," but not in the same section explaining the operations (indicates that the content has some information).

	Indicates that you press the button briefly .
	Indicates that you press the button briefly and repeatedly until an option you want is selected.
	Indicates that you press one of the buttons.
	Indicates that you press and hold the button for a specified period.
	Indicates that you turn the control toward the specified direction(s).
	Indicates that this operation is only possible using the remote control.
	Indicates that this operation is only possible using the main unit.

"DVD Logo" is a trademark of DVD Format/Logo Licensing Corporation registered in the US, Japan and other countries.

Caution for DualDisc playback

The Non-DVD side of a "DualDisc" does not comply with the "Compact Disc Digital Audio" standard. Therefore, the use of the Non-DVD side of a DualDisc in this product is not recommended.

Connections INFO

Do not connect the AC power cord until all other connections have been made.

- Connect VIDEO OUT directly to the video input of your TV. Connecting VIDEO OUT to a TV via a VCR may interfere with your viewing when playing back a copy-protected disc. Connecting VIDEO OUT to an integrated TV/VCR system may also interfere with your viewing.

Supplied accessories

Check to be sure that you have all the following items.

- FM antenna (x1)
 - AM loop antenna (x1)
 - Composite video cord (x1)
 - Core filter* (x1)
 - Remote control (x1)
 - Batteries (x2)
 - AC plug adapter (x1) (except for the Middle East)
- If any item is missing, consult your dealer immediately.

Rear panel

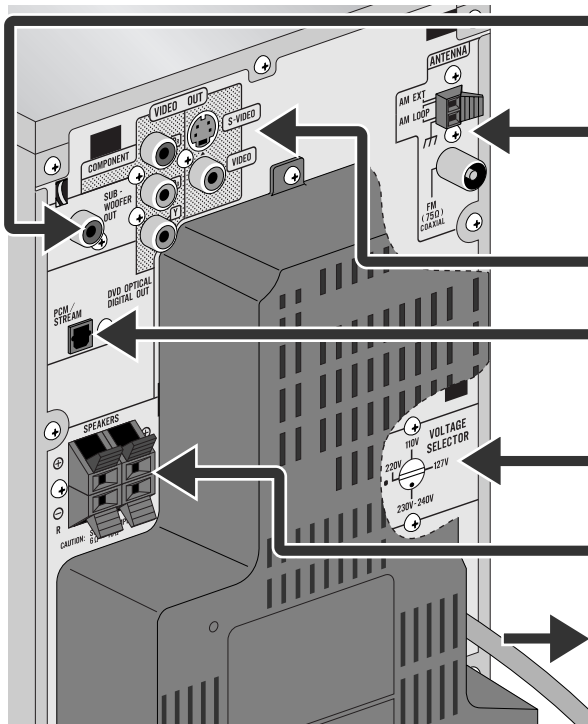

1 From the powered subwoofer
See page 4.

2 From AM/FM antenna
See page 4.

3 From the input of TV/monitor
See page 4.

4 From the digital input of digital audio component
See page 4.

Voltage selector: See page 5.

5 From the speakers
See page 5.

6 To a wall outlet
Plug in the AC power cord only after all connections are complete.
• If the wall outlet does not match the AC plug, use the supplied AC plug adapter (except for the Middle East).

Front panel

Pull down the cover until you hear a clicking sound.

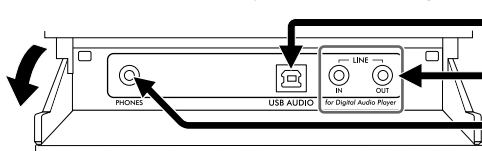

1 From the PC: See page 12.

2 From the portable audio device: See page 5.

3 From the headphones: See page 7.

*Attaching the core filter to the USB cable to reduce interference

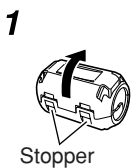

2 At the front panel

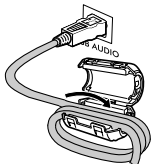

- Wind firmly the USB cable twice.
- Keep close between the plug connected to the System and the core filter.
 - Do not damage the USB cable by applying excessive force when winding.

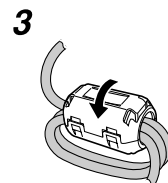

Close the core filter until you hear a clicking sound.

1 Powered subwoofer

From the powered subwoofer (not supplied)

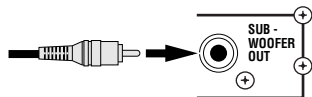

The subwoofer connected can reproduce the bass sounds recorded in front left and right channels, but cannot reproduce the LFE signals in DVD multi-channel discs.

- Before plugging the unit to the main supply, make sure that the powered subwoofer is turned off.

2 AM/FM antenna

To assemble the AM loop antenna

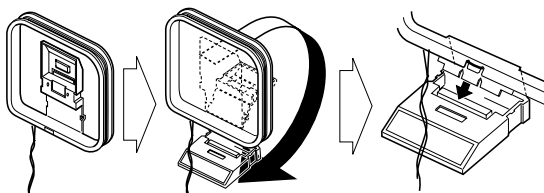

To connect AM/FM antenna

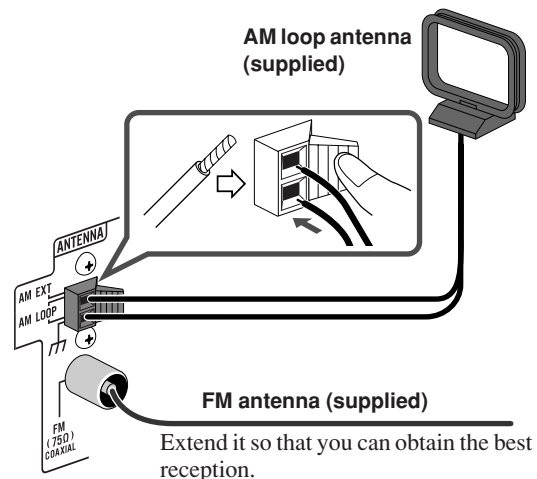

For better AM/FM reception

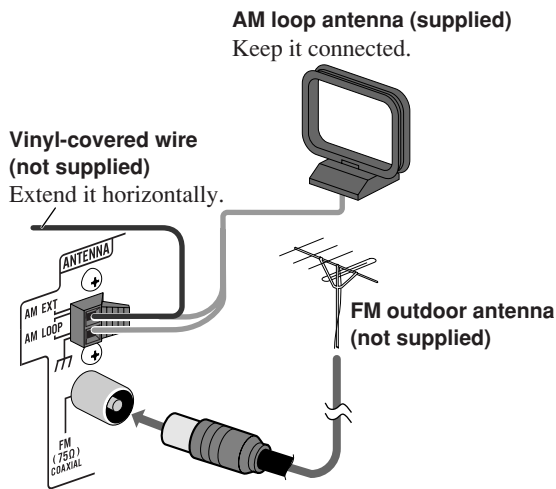

- Disconnect the supplied FM antenna, and connect to an outdoor FM antenna using a 75 Ω wire with coaxial type connector (IEC or DIN45325).

3 TV/monitor

Connect only component cord at one time.

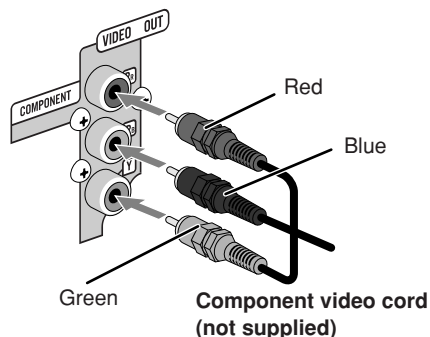

- To select progressive scanning mode (see page 15), use COMPONENT jacks.

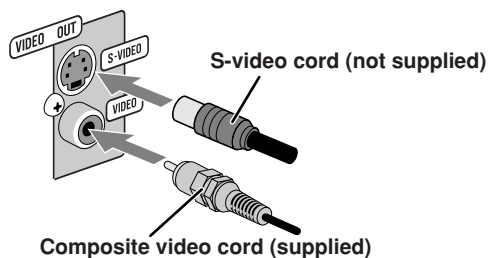

- After connecting a TV, select the proper video signal mode according to the connection method. See “Changing the Scanning Mode” on page 15.

4 Digital audio component

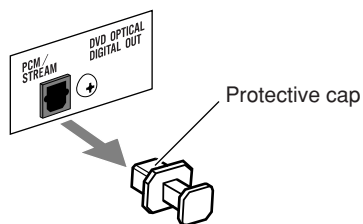

- Set “DIGITAL AUDIO OUTPUT” in the “AUDIO” menu correctly according to the connected digital audio equipment (see page 37). If the setting is incorrect, loud noise may be generated causing damage to the speakers.
- Digital audio signals are output from this System only when “DVD/CD” is selected as the source.

5 Speakers

- When connecting the speaker cords, match the polarity of the speaker terminals: red color to (+) and black color to (-).

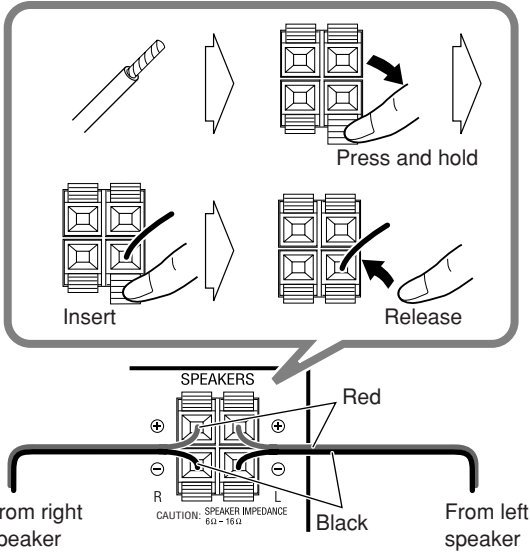

- DO NOT connect more than one speaker to each terminal.
- DO NOT push or pull the speakers as this will damage the foot spacers at the bottom of the speakers.



When connecting a portable audio device (LINE)

Portable audio device
(Digital Audio Player, etc.)

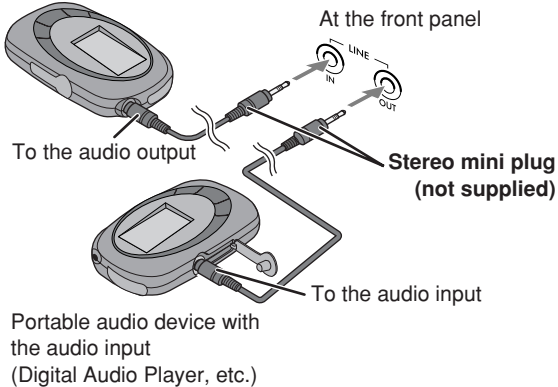

- By using QP Link (Quick Portable Link), you can easily start playing back a portable audio device on this unit when connecting it to the LINE IN jack. See page 12 for details.
- Connect an audio component to the LINE OUT jack if the component is not equipped with a digital input terminal.
- If an external device is not equipped with a stereo mini plug audio output, use a plug adaptor to convert the stereo mini plug to the corresponding plug of the audio output.

Before plugging in the System

Set the correct voltage for your area with the voltage selector on the rear.

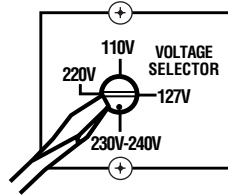

Use a screwdriver to set the voltage selector to the same voltage as where you are plugging in the unit. (See also the back cover page.)

Preparing the remote control

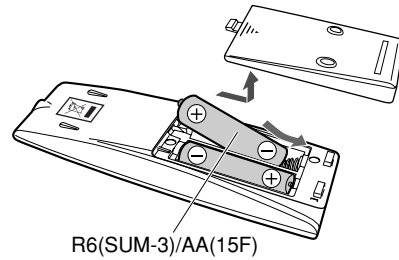

- Dispose of batteries in the proper manner, according to federal, state, and local regulations.



DO NOT recharge, short, disassemble, heat the battery or dispose of it in a fire.

When using the remote control

Point the top of the remote control toward the remote sensor as directly as possible. If you operate it from a diagonal position, the operating range (approx. 5 m) may be shorter.

Display Indicators

The indications on the display tell you a lot of things while you are operating the System. Before operating the System, be familiar with when and how the indicator illuminates on the display.

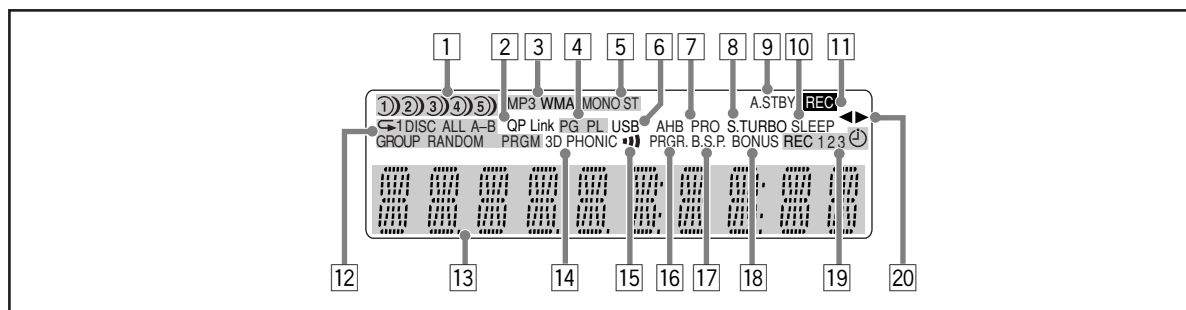

- 1 Disc tray indicators
 - 1–5: Disc tray number indicators.
 - Flashing while the disc tray is open.
 - ☉ (disc tray indicator):
 - Lights when the disc is detected.
 - Flashing while playing back a disc or the disc tray is open.
 - Disappears when there is no disc in the tray.
 - ☺: Lights to indicate the current selected disc.
- 2 QP Link (Quick Portable Link) indicator
 - Lights when QP Link is activated.
- 3 Audio file format indicators
 - MP3: lights when an MP3 track is detected.
 - WMA: lights when a WMA track is detected.
- 4 PG/PL indicators
 - PG: lights when a DVD-VR formatted disc is called up.
 - PL: lights when a playlist recorded on a DVD-VR formatted disc is called up.
- 5 FM reception indicators
 - MONO: lights while receiving an FM stereo station in monaural.
 - ST (stereo): lights while an FM stereo station with sufficient signal strength is tuned in.
- 6 USB indicator
 - Lights when “USB” is selected as the source.
- 7 AHB PRO indicator
 - Lights when Active Hyper Bass Pro is activated.
- 8 S.TURBO (Sound Turbo) indicator
 - Lights when Sound Turbo II is activated.
- 9 A.STBY (Auto Standby) indicator
 - Lights when Auto Standby is activated.
 - Flashes for about 3 minutes before Auto Standby turns the System off.
- 10 SLEEP indicator
 - Lights when the Sleep Timer is activated.
- 11 REC indicator
 - Lights while recording.
- 12 Playback mode indicators
 - PRGM: lights when Program Play is activated.
 - RANDOM: lights when Random Play is activated.
 - ☺ (repeat) 1 DISC A-B ALL GROUP:
 - ☺ 1 : lights when One Track/Chapter/Step Repeat is activated.
 - ☺ ,GROUP : lights when Group Repeat is activated.
 - ☺ ,1,DISC : lights when One Disc Repeat is activated.
 - ☺ ,DISC,ALL : lights when All Disc Repeat is activated.
 - ☺ ,A-B : lights when A-B Repeat is activated.
- 13 Main display
 - While listening to radio: Band (or preset number) and station frequency appear.
 - While selecting “LINE”: “LINE” appears.
 - While selecting “TAPE”: “TAPE” appears.
 - While selecting “USB”: “USB AUDIO” appears.
 - While playing a disc: current status appears.
- 14 3D PHONIC indicator
 - Lights when 3D Phonic is activated.
- 15 ☺ (Clear Voice) indicator
 - Lights when Clear Voice is activated.
- 16 PRGR. (Progressive) indicator
 - Lights when the progressive scanning mode is selected.
- 17 B.S.P. (Browsable Still Picture) indicator
 - Lights when Browsable Still Pictures are detected while playing a DVD Audio disc.
- 18 BONUS indicator
 - Lights when a DVD Audio disc with a bonus group is detected.
- 19 Daily Timer indicators
 - 1/2/3: lights when a Daily Timer (1, 2, or 3) is on standby; flashes while working or being set.
 - ☺ : lights when Daily Timer is on standby or is being set.
 - REC: lights when the Recording Timer stands by; flashes while working or being set.
- 20 ◀▶ (tape direction) indicators
 - Lights to indicate the current tape running direction.
 - Flashes slowly during playback and recording.
 - Flashes quickly while rewinding or fast-forwarding a tape.

Daily Operations—Playback

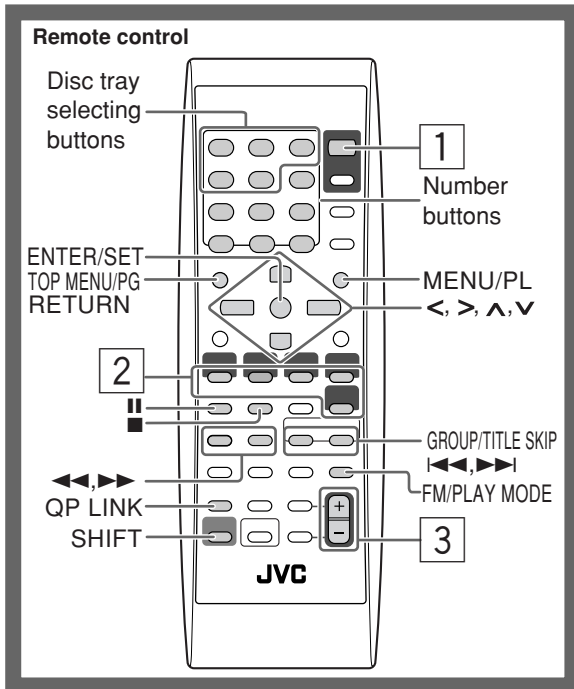

In this manual, operations using the remote control are mainly explained; however, you can use the buttons and controls on the main unit if they have the same (or similar) name and marks.

1 Turn on the power.

The STANDBY lamp on the main unit goes off.

- Without pressing **⏻/I AUDIO**, the System turns on by pressing one of the source buttons.
- The System turns on and changes the source to **LINE** by starting playback on an external device when QP Link is activated. (See page 12 for details.)

2 Select the source.

Playback automatically starts if the selected source is ready.

- If you press **LINE**, start playback on the external component.

3 Adjust the volume.

4 Operate the target source as explained later.

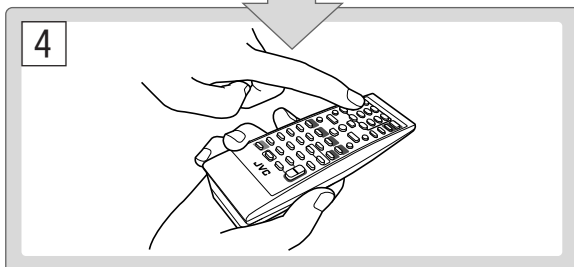
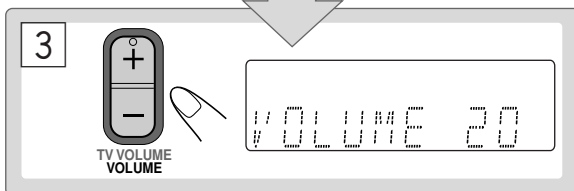
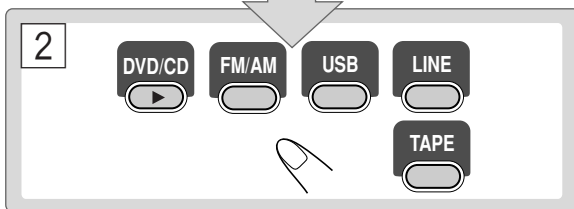
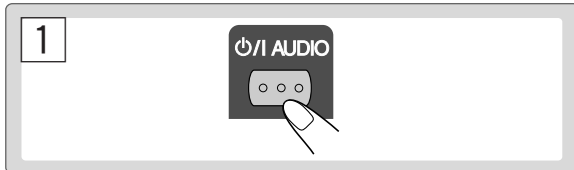

To turn off (standby) the unit



The STANDBY lamp on the main unit lights in red.

- A small amount of power is always consumed even while on standby.

You can reduce power consumption by pressing **DISPLAY** to turn the display off while on standby.

- When the display is turned off, QP Link does not work.

For private listening

Connect a pair of headphones to the PHONES jack on the main unit. The sound will no longer come out of the speakers. **Be sure to turn down the volume before connecting or putting on the headphones.**

- Disconnecting the headphones will activate the speakers again.



DO NOT turn off (standby) the System with the volume set to an extremely high level; otherwise, the sudden blast of sound can damage your hearing, speakers and/or headphones when you turn on the System or start playback.

Listening to the Radio INFO

To set the AM tuner interval spacing

Before operating the tuner, it is required to select the appropriate AM space interval used for your area.

- This is possible only while the System is on standby.

1 Select the AM band.

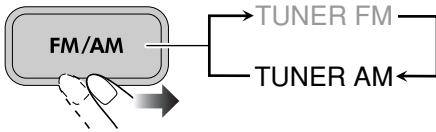

2 Turn off the power.

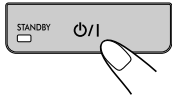

3 Select the appropriate AM space interval for your area.

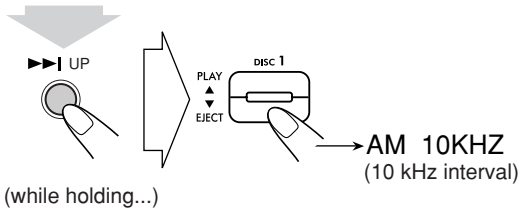
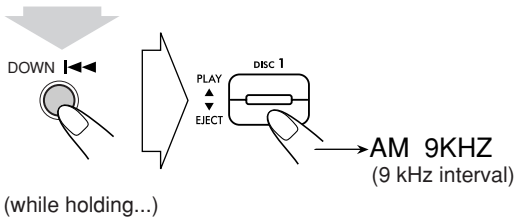

To select the band (FM or AM)

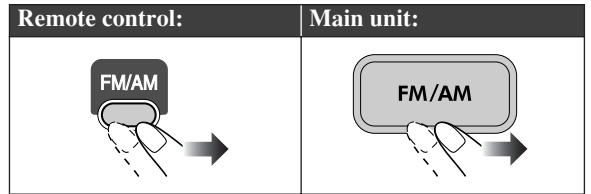

To tune in to a station

While FM or AM is selected...

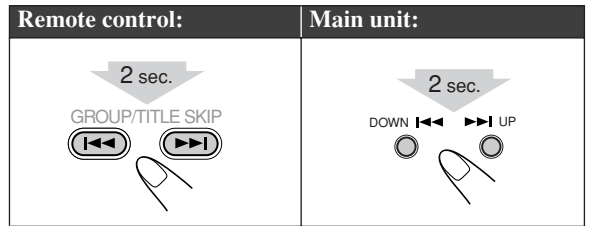

Frequency starts changing on the display.

When a station (frequency) with sufficient signal strength is tuned in, the frequency stops changing.

- When you repeatedly press the button, the frequency changes step by step.

To stop searching manually, press either button.

If the FM station has poor reception

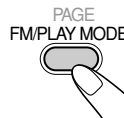

The MONO indicator lights on the display. Reception will improve though stereo effect is lost—Monaural reception.

To restore the stereo effect, press the button again (the MONO indicator disappears).

To preset the stations

You can preset 30 FM and 15 AM stations.

1 Tune in to a station you want to preset.

- You can also store the monaural reception mode for FM preset stations if selected.

2 Activate the preset number entry mode.

ENTER/SET

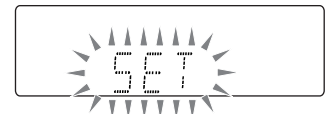

- Finish the following process while the indication on the display is flashing.

3 Select a preset number for the station you store.

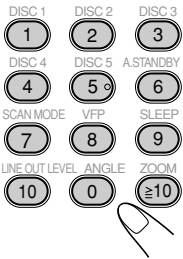

Examples:

To select preset number 5, press 5.

To select preset number 10, press 10.

To select preset number 15, press \cong 10, 1, then 5.

To select preset number 30, press \cong 10, 3, then 0.

- You can also use the \gg or \ll button.

4 Store the station.

ENTER/SET

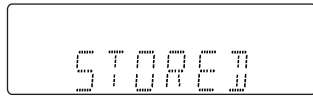

To tune in to a preset station



1 Select the band (FM or AM).

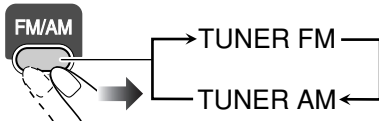

2 Select the preset number for the station you stored.



Examples:

To select preset number 5, press 5.

To select preset number 10, press 10.

To select preset number 15, press \cong 10, 1, then 5.

To select preset number 30, press \cong 10, 3, then 0.

- You can also use the \gg or \ll button.

Playing Back a Tape

To insert a tape

You can playback type I tapes.

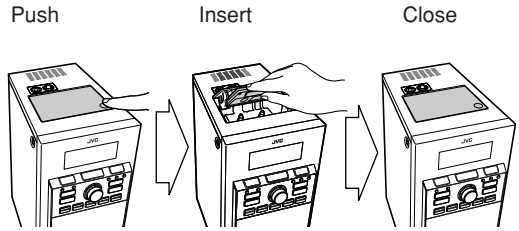

With the tape side facing outside

To start:	To stop:
<p>When "TAPE" is not selected as the current source, press twice.</p>	
To rewind/fast-forward the tape:	
Remote control:	
	<p>Fast-forward the tape.</p>
<p>Rewind the tape.</p>	
Main unit:	
	Rewind the tape.
	Fast-forward the tape.

Playing Back a Disc INFO

Before operating a disc, be familiar how a disc is recorded.

- DVD Video/DVD-VR comprises of “Titles” which includes “Chapters,” DVD Audio/MP3/WMA/MPEG-1/MPEG-2/ASF/DivX comprises of “Groups” which includes “Tracks,” JPEG comprises of “Groups” which includes “Files,” and CD/SVCD/VCD comprises of only “Tracks.”
- For playback of MP3/WMA/JPEG/MPEG-1/MPEG-2/ASF/DivX, see also page 27.

To insert a disc

You can insert a disc while playing another source.

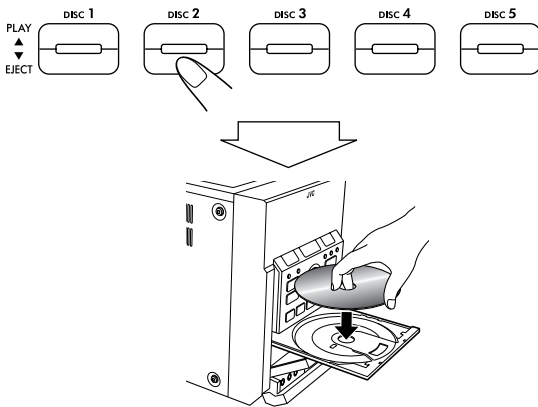

- When using an 8 cm disc, place it on the inner circle of the disc tray.

To close the disc tray, press the upper part of the same button. The tray closes and playback starts.

- When current selected disc tray is open, you can use DVD/CD ► to close the disc tray and start playback (depending on how the disc is programmed internally).
- While one of the trays is open, the tray closes automatically by pressing down EJECT for the next tray, then the next tray comes out.

To start:	To pause:	To stop:
	To release, press DVD/CD ►.	

- **While playing DVD/SVCD/VCD/MP3/WMA/MPEG-1/MPEG-2/ASF/DivX:** This System can store the stop point, and when you start playback again by pressing DVD/CD ► (even while on standby), it starts from the position where you have stopped—Resume Play. (“RESUME” appears on the display when you stop playback.)

To stop completely while Resume is activated, press ■ twice. (To cancel Resume, see “RESUME” on page 37.)

- When operating the System, the on-screen guide icon (see the following table) appears on the TV.

On-screen guide icons

- During DVD Video playback, the following icons may appear on the TV:

At the beginning of a scene containing multi-angle views.

At the beginning of a scene containing multi-audio sounds.

At the beginning of a scene containing multi-subtitles.

- The following icons will be also shown on the TV to indicate your current operation.

- To deactivate the on-screen guide icons, see “ON SCREEN GUIDE” in “OTHERS menu” on page 37.

To select a disc

Remote Control:

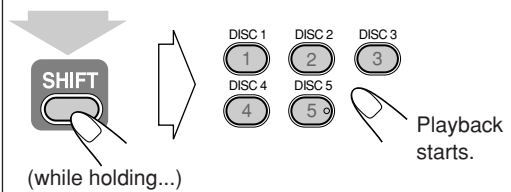

Main Unit:

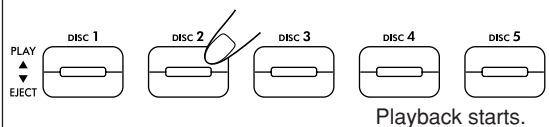

To select a title/group



While playing a disc...

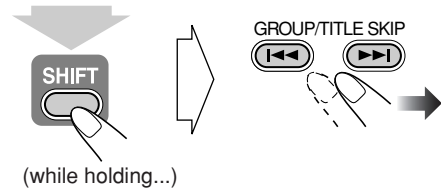

- You can select a title/group directly by pressing a number button after pressing GROUP/TITLE (except for DVD-VR disc).
- Group name appears for MP3/WMA playback.

To select a chapter/track

- For VCD/SVCD, cancel PBC (see the right column).

While playing a disc...



- First time you press \lll , you will go back to the beginning of the current chapter/track.

To locate a particular portion



While playing a disc...



- Search speed changes as illustrated above except for MP3/WMA/DivX discs. For MP3/WMA/DivX discs, search speed and the indications on the TV are different.
- No sound comes out if searching is carried out while showing the moving picture.

To return to normal playback, press DVD/CD \blacktriangleright .

- For DivX, each time you press the $>$ or $<$ button, you can skip to a scene for 30 seconds or 5 minutes depending on the DivX file.

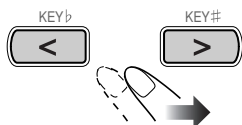

To locate an item directly



You can select a title/chapter/track directly and start playback.

- For DVD Video, you can select a **title before starting playback**, while you can select a **chapter after starting playback**.



Examples:

- To select number 5, press 5.
- To select number 10, press 10.
- To select number 15, press \cong 10, 1, then 5.
- To select number 30, press \cong 10, 3, then 0.

To playback using the disc menu



- For DVD Video/DVD Audio:

1 Show the disc menu.

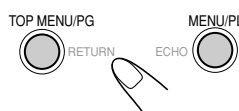

2 Select an item on the disc menu.

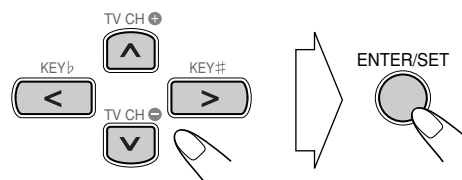

- With some discs, you can also select items by entering the number using the number buttons.

- For SVCD/VCD with PBC:

While playing a disc with PBC, "PBC" appears on the display.

When disc menu appears on the TV, select an item on the menu. Playback of the selected item starts.



Examples:

- To select number 5, press 5.
- To select number 10, press 10.
- To select number 15, press \cong 10, 1, then 5.
- To select number 30, press \cong 10, 3, then 0.

To move to the next or previous page of the current menu:

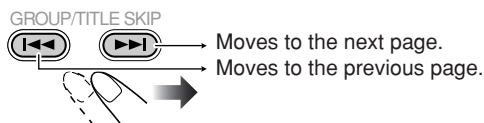

To return to the previous menu:

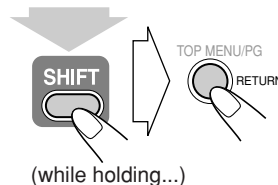

To cancel PBC, press \blacksquare , then select a track. Playback starts with the selected track.

To reactivate PBC, press \blacksquare (twice if Resume is turned "ON"), then press DVD/CD \blacktriangleright .

Playing Back a Portable Audio Device **INFO**

By using QP Link (Quick Portable Link), you can easily start playing back a portable audio device connected to the LINE IN jack (see page 5).

- Make sure to set the volume of your portable audio device loud enough so that the System can detect the sound signal.

To activate QP Link

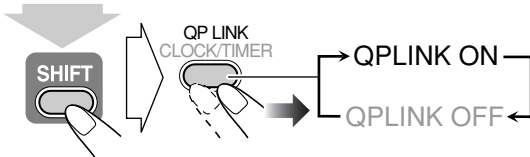

(while holding...)

When QP Link is activated, connecting a portable device to the LINE IN jack and starting playback performs the following:

- While listening to another source...
Changes the source to LINE automatically. (If you change from LINE to another source, QP Link will be canceled.)
- While the System is on standby...
Turns on the System and activates the LINE source automatically (except when the display is turned off).

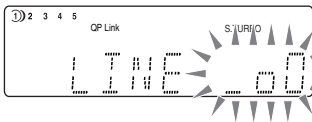

Bubbles appear when QP Link works.

While QP Link plays back the device...

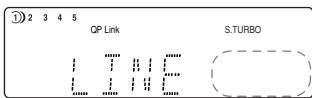

Bubbles disappear when the sound signal stops or is too weak.

Playing Back from the PC **INFO**

This System is equipped with a USB AUDIO terminal on the front panel. You can connect your PC to this terminal and enjoy sound reproduced through your PC.

When you connect your PC for the first time, follow the procedure below.

- Remember you cannot send any signal or data to your PC from this System.

IMPORTANT

- Always set volume to “VOL MIN” when connecting or disconnecting the other equipment.

How to install the USB drivers

- 1 Turn on your PC and start running Windows® 98*, Windows® 98SE*, Windows® Me*, Windows® 2000*, or Windows® XP*.
 - If the PC has been turned on, quit all the applications running.

- 2 Select “USB” as the source.

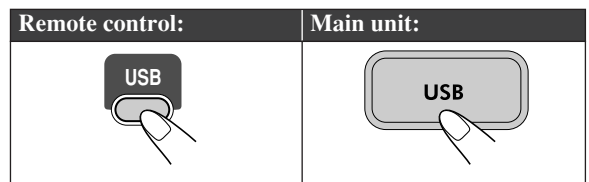

- 3 Connect the System to the PC using a USB cable (not supplied).

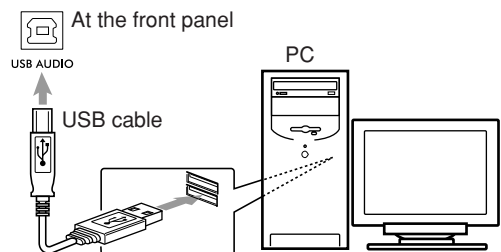

- Use “USB series A plug to B plug” cable less than 3 m.

- 4 The USB drivers are installed automatically.

To playback sound on the PC

Refer to the manuals supplied with the sound reproduction application installed in the PC.

- Noise and static electricity may stop the sound through the USB connection. In this case, do the following operations:
 - Disconnect and connect the USB cable again
 - Restart the music software on your PC
 - Turn off and on the System

*Microsoft®, Windows® 98, Windows® 98SE, Windows® Me, Windows® 2000 and Windows® XP are registered trademarks of Microsoft corporation.

Daily Operations—Sound & Other Adjustments

Remote control

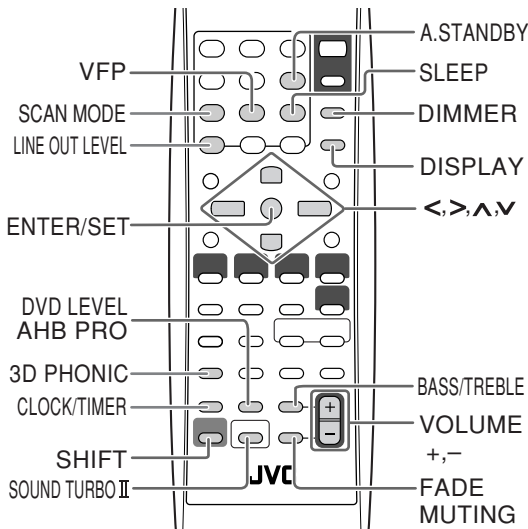

Main unit

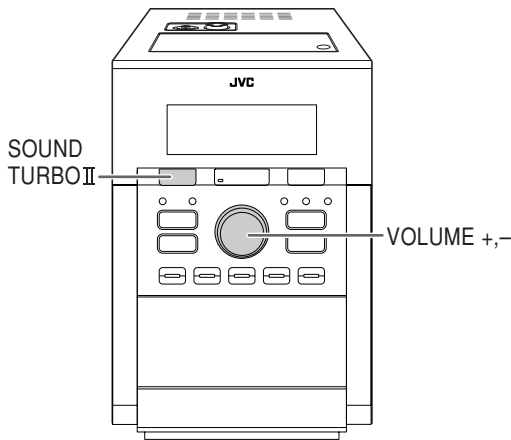

Adjusting the Volume

You can adjust the volume level from VOL MIN to level 40 (VOL MAX).

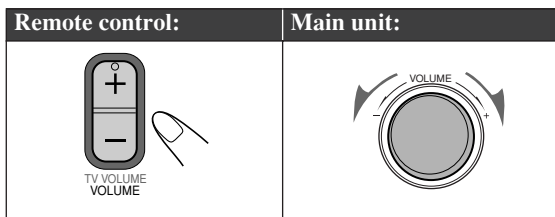

To drop the volume in a moment



To restore the volume, press again, or adjust the volume level.

Adjusting the Sound

INFO

To reinforce the heavy sound

This boosts the low and high frequency sound—Sound Turbo II.

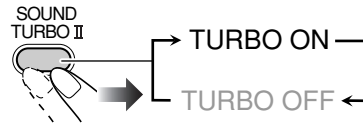

- When Sound Turbo II is turned on, AHB Pro is automatically turned on, and cannot be turned off. (AHB PRO indicator does not light even though the function is turned on.)

To reinforce the bass sound



While Sound Turbo II is off, the richness and fullness of the bass sound is clearly maintained regardless of how you set the volume—Active Hyper Bass Pro.

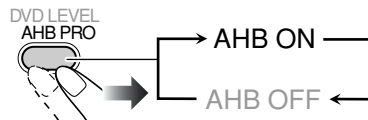

- When Sound Turbo II is turned on, AHB Pro setting cannot be changed.

To adjust the tone



You can adjust the bass and treble level from -3 to +3.

To adjust the bass



To adjust the treble



Creating 3-dimensional Sound Field

3D Phonic



- This does not function for MPEG-1/MPEG-2/ASF/DivX discs.

While playing a disc...

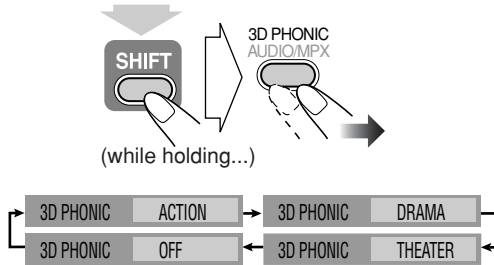

- The selected mode can only be shown on the TV.

ACTION Suitable for action movies and sports programs.

DRAMA Creates natural and warm sound. Enjoy movies in a relaxed mood.

THEATER Enjoy sound effects like in a major theater.

Presetting Automatic DVD Video Sound

Increase Level



DVD Video sound is sometimes recorded at a lower level than other discs and sources. You can set the increase level for the currently loaded DVD Video, so you do not have to adjust the volume when you change the source.

- This only functions for DVD Video and DVD-VR format disc.

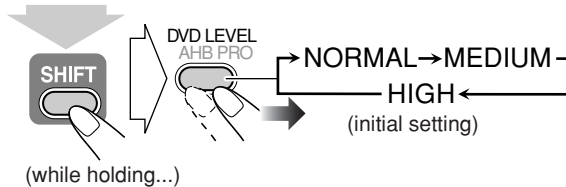

NORMAL Original recording level.

MEDIUM Output level is increased (less than "HIGH").

HIGH Output level is increased (more than "MEDIUM"). (initial setting)

Adjusting the Audio Input Level



If the sound from the component connected to the LINE IN jack is too loud or is too quiet when changing from another source to LINE, you can change the audio input level through the LINE IN jack (without changing the volume level).

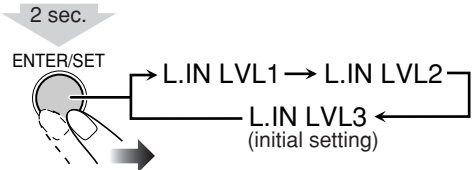

L.IN LVL1 Select this when the sound is too loud with "L.IN LVL 2" selected. This setting is recommended when connecting an audio device other than a portable audio device to the LINE IN jack.

L.IN LVL2 Select this when the sound is too loud with "L.IN LVL 3" selected.

L.IN LVL3 Select this when listening to a portable audio device or recording the sound from it (initial setting).

Adjusting the Audio Output Level



If the recorded sound on the device connected to the LINE OUT jack is too loud or too quiet, you can change the audio output level through the LINE OUT jack (without changing the volume level).

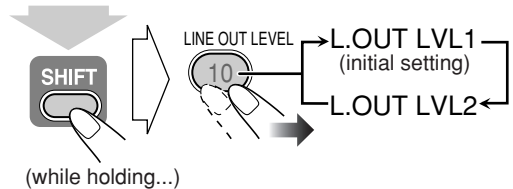

L.OUT LVL1 Select this when recording the sound with a portable audio device (initial setting).

L.OUT LVL2 Select this when the recorded sound is too loud with "L.OUT LVL 1" selected.

Changing the Display Brightness

You can dim the display window.

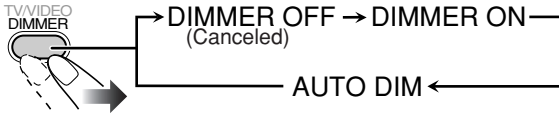

DIMMER ON Dims the display.

AUTO DIM* Removes the display illumination when starting playback a disc with a video source.

- The display illuminates when playback stops.

* "AUTO DIM" does not work for CD/MP3/WMA.

Changing the Scanning Mode Remote ONLY INFO

This System supports progressive scanning.

Select the video signal mode according to the type of your TV. If you connect a progressive TV through the VIDEO OUT jacks, you can enjoy a high quality picture from the built-in DVD player by selecting "NTSC PROG" or "PAL PROG."

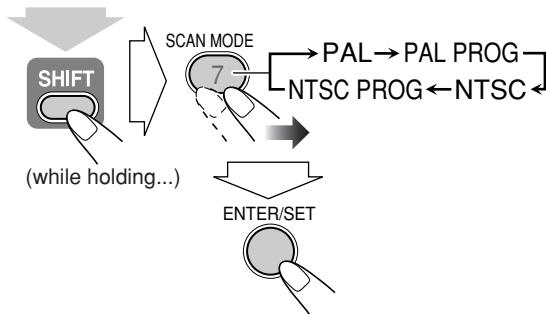

NTSC Select for a conventional NTSC TV.

NTSC PROG Select for a progressive NTSC TV. Select to enjoy a progressive scanned picture through the Video Component out terminal.

PAL Select for a conventional PAL TV.

PAL PROG Select for a progressive PAL TV. Select to enjoy a progressive scanned picture through the Video Component out terminal.

Changing the Picture Tone Remote ONLY

While showing a playback picture on the TV, you can select a preset picture tone, or adjust it and store your own taste.

To select a preset picture tone

1 While playing, display VFP setting screen.

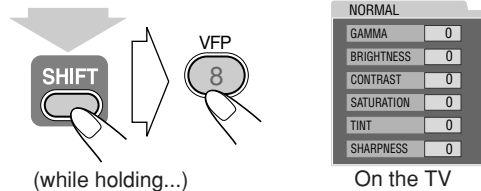

NORMAL	
GAMMA	0
BRIGHTNESS	0
CONTRAST	0
SATURATION	0
TINT	0
SHARPNESS	0

On the TV

2 Select a preset picture tone.

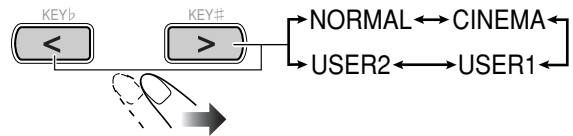

NORMAL Normally select this.

CINEMA Suitable for a movie source.

USER1/USER2 You can adjust parameters and can store the settings.

To remove the screen, press VFP again while holding SHIFT, or wait for more than 5 seconds.

To adjust the picture tone

1 Select "USER1" or "USER2."

Follow steps 1 and 2 explained above.

2 Select a parameter you want to adjust.

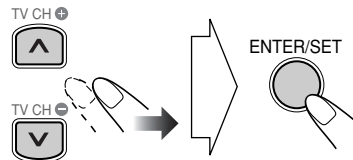

GAMMA Adjust if the neutral color is bright or dark (-3 to +3).

BRIGHTNESS Adjust if the entire picture is bright or dark (-8 to +8).

CONTRAST Adjust if the far and near positions are unnatural (-7 to +7).

SATURATION Adjust if the picture is whitish or blackish (-7 to +7).

TINT Adjust if the human skin color is unnatural (-7 to +7).

SHARPNESS Adjust if the picture is indistinct (-8 to +8).

Continued on the next page

3 Adjust the parameter.

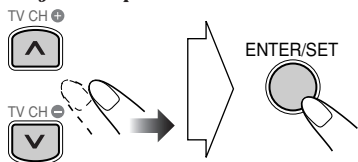

4 Repeat steps 2 to 3 to adjust other parameters.

To erase the screen, press VFP again while holding SHIFT, or wait for more than 5 seconds.

Setting the Clock

Remote ONLY

INFO

Without setting the built-in clock, you cannot use Daily Timers (see page 34) and Sleep Timer.

- To correct a mis-entry during the process, press CANCEL or CLOCK/TIMER. You can return to the previous step.

1 Activate the clock setting mode.

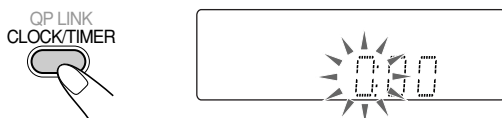

- If you have already adjusted the clock before, press the button repeatedly until the clock setting mode is selected.

2 Set the time.

- Adjust the hour and press ENTER/SET, then adjust the minute and press ENTER/SET.

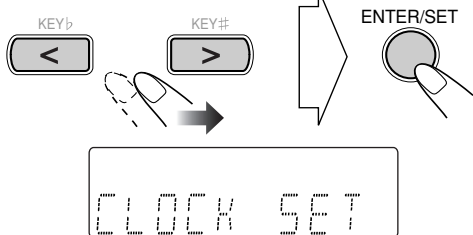

Now the built-in clock starts working.

To check the current clock time during play

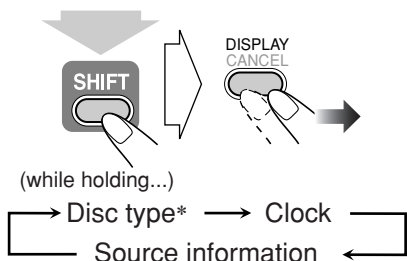

* This appears depending on the disc type.

Turning Off the Power Automatically

Remote ONLY

Auto Standby

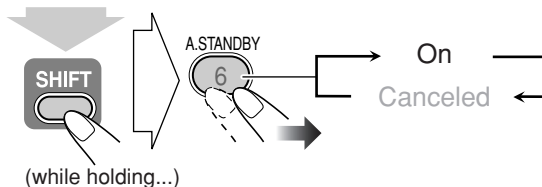

When Auto Standby is in use, the A.STBY indicator lights on the display.

When disc play stops, the A.STBY indicator starts flashing. If no operation is done for about 3 minutes while the indicator is flashing, the System turns off (on standby) automatically.

Sleep Timer

You can set the shut-off time so that you can go to bed without turning it off yourself.

1 Specify the time (in minutes).

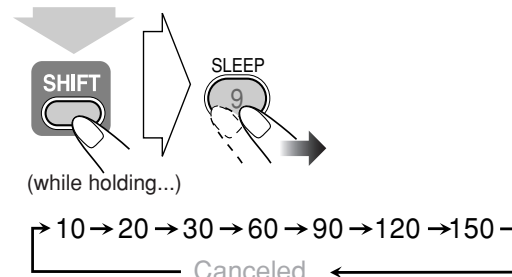

2 Wait until the set time disappears.

To check the time remaining until the shut-off time, press SLEEP while holding SHIFT.

- If you press the button repeatedly, you can change the shut-off time.

Unique DVD/VCD Operations

Remote control

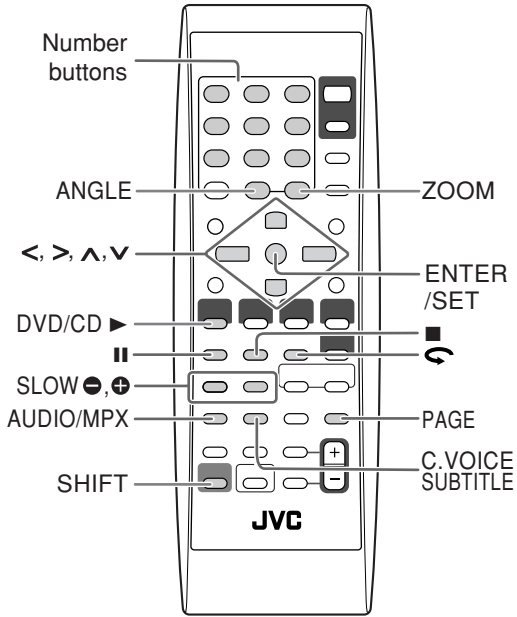

Selecting the Audio Track



For DVD Video/DivX: While playing back a chapter containing audio languages, you can select the language to listen to.

For DVD Audio: While playing back a track containing audio channels, you can select the audio channel to listen to.

For DVD-VR and Karaoke CD/SVCD/VCD: When playing back a track, you can select the audio channel to play.

- You can also select the audio track using the on-screen bar (see page 23).



While playing a DVD Video...

Ex.:

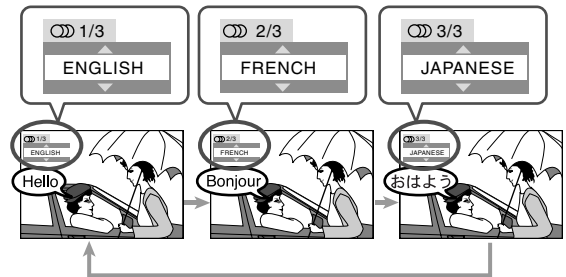

While playing a DVD Audio/DivX...

Ex.:

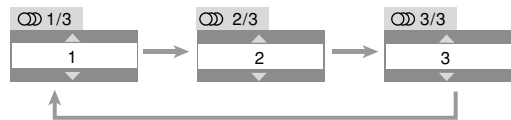

While playing a DVD-VR, or Karaoke CD/SVCD/VCD...

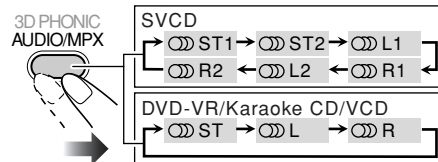

ST1/ST2/ST To listen to normal stereo (2-channel) playback.

L1/L2/L To listen to the left audio channel.

R1/R2/R To listen to the right audio channel.

- SVCD can have 4 audio channels. SVCD usually uses these 4 channels to record two 2-channel recordings (ST1/ST2).

Selecting the Subtitle Language

For DVD Video/DivX: While playing back a chapter containing subtitles in different languages, you can select the subtitle language to display on the TV.

For DVD-VR: While playing, you can turn the subtitles on or off.

For SVCD: While playing, you can select the subtitles even if no subtitles are recorded on the disc.

- You can also select the subtitle language using the on-screen bar (see page 23).

While playing a DVD Video/DivX...

1

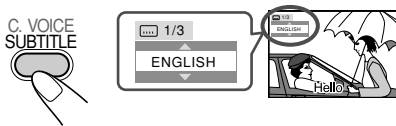

2

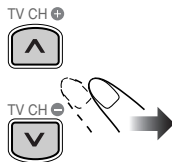

Ex.:

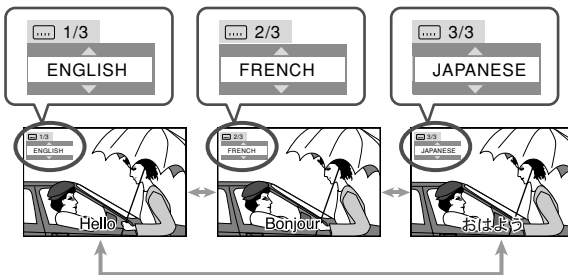

While playing a DVD-VR...

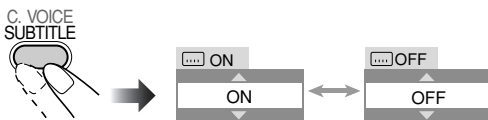

While playing an SVCD...

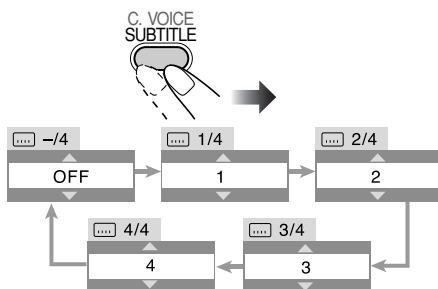

Selecting the View Angle

For DVD Video only: While playing back a chapter containing multi-view angles, you can view the same scene from different angles.

- You can also select the multi-view angles using the on-screen bar (see page 23).

While playing...

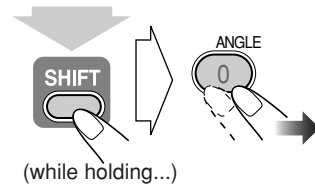

Ex.:

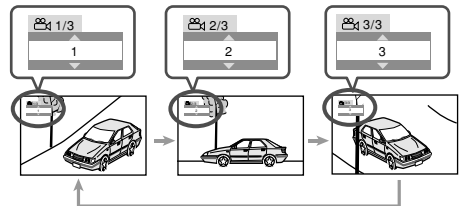

Selecting the Browsable Still Pictures

For DVD Audio only: While playing back a track linked to browsable still pictures (B.S.P.), you can select the still picture (turn the page) to be shown on the TV screen.

- If a track is linked to browsable still pictures (B.S.P.), they are usually shown automatically during playback.
- You can also select the page using the on-screen bar (see page 23).

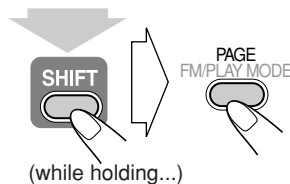

Each time you press the button (while holding SHIFT), the still picture changes one after another (if available).

Playing Back Bonus Group

For DVD Audio only: Some DVD Audio discs have a special group called "bonus group" whose contents are not open to the public.

- To playback a bonus group, you have to enter the specific "key number" (a kind of password) for the bonus group. The way of getting the key number depends on the disc.

1 Select the bonus group.

- The bonus group is usually recorded as the last group (for example, if a disc contains 4 groups including a bonus group, "group 4" is the bonus group).
- For how to select the group, see "To select a title/group" on page 10.

2 Enter the key number.

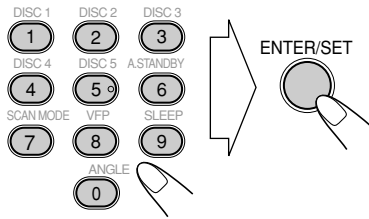

3 Follow the interactive instructions shown on the screen.

To cancel the key number entry, press ■.

Making Dialogues Clear—Clear Voice Remote ONLY >>>

When you playback a disc, you can use this function—Clear Voice. You can make the singer's voices or dialogues of the movie clear.

- This function only works when 3D Phonic is activated.

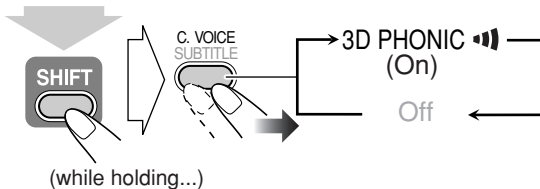

Special Effect Playback Remote ONLY >>> INFO ●

Pause playback

To pause:	To resume normal playback:
While playing... 	

Frame-by-frame playback

1 While playing...



2 Advance the still picture frame by frame.



To resume normal playback, press DVD/CD ►.

Slow-motion playback

- This does not function for MPEG-1/MPEG-2/ASF/DivX discs.

1 While playing...



Still picture playback starts.

2 Select slow motion speed.

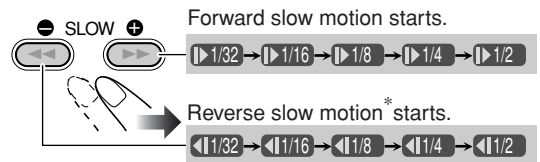

*Only available for DVD Video.

To resume normal playback, press DVD/CD ►.

To replay the previous scenes (One-Touch Replay)

- This function is only used while playing DVD Video/DVD-VR.

While playing back...



The playback position moves back about 10 seconds before the current position (only within the same title).

Zoom

- For JPEG, see page 28.

1 While playing back...

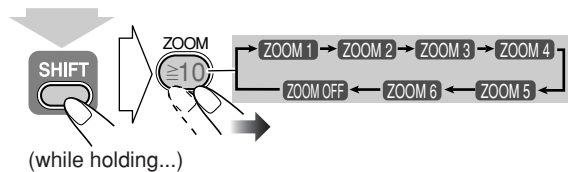

- As the number increases, magnification also increases.

2 Move the zoomed-in position.

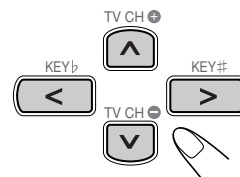

To cancel Zoom, press ZOOM (while holding SHIFT) repeatedly until "ZOOM OFF" appears on the TV.

Advanced Disc Operations

Remote control

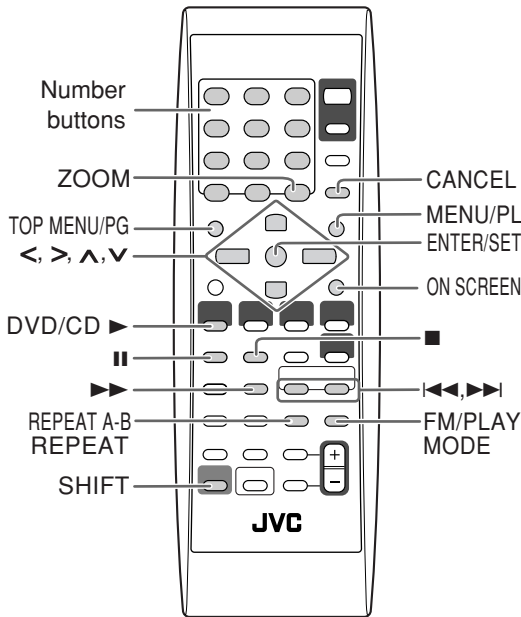

Main unit

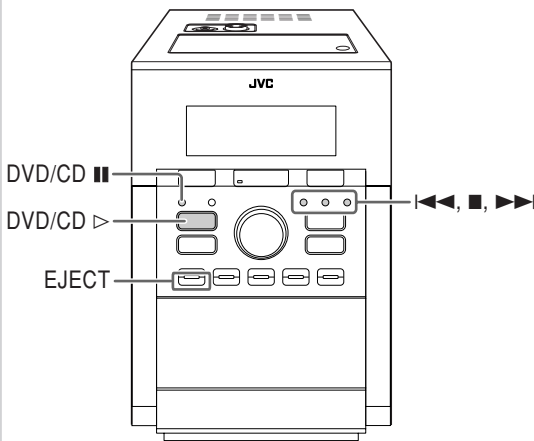

Programming the Playing Order

Program Play

Remote ONLY

INFO

You can arrange the playing order of the chapters or tracks (up to 99) before you start playback.

- Program play cannot be used for DVD-VR/JPEG/MPEG-1/MPEG-2/ASF/DivX.
- Resume does not work for Program Play.

1 Before starting playback, activate Program Play.

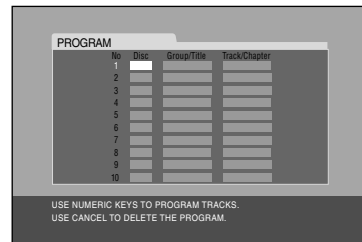
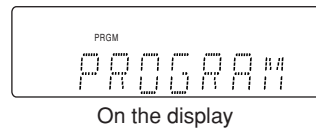
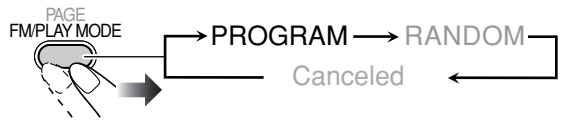

2 Select chapters or tracks you want for Program Play.

• For DVD Video/DVD Audio/MP3/WMA:

- ① Select a disc number.
- ② Select a title or group number.
- ③ Select a chapter or track number.
- ④ Repeat the above steps ① to ③.

• For SVCD/VCD/CD:

- ① Select a disc number.
- ② Select tracks.
- ③ Repeat the above steps ① and ②.

To enter the numbers directly:

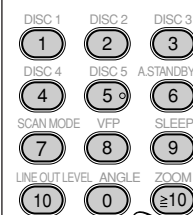

Examples:

- To enter number 5, press 5.
- To enter number 10, press 10.
- To enter number 15, press ≥ 10 , 1, then 5.
- To enter number 30, press ≥ 10 , 3, then 0.

3 Start playback.



Playback starts in the order you have programmed.

To skip a step:	To pause:	To stop:
<p>GROUP/TITLE SKIP</p>	<p>To release, press DVD/CD ▶.</p>	

To check the programmed contents

Before or after playback...

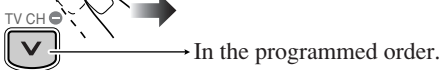
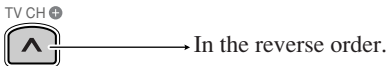

- You can also use ◀◀ or ▶▶ to check the programmed contents.

To modify the program

Before or after playback...

To erase the last track:	To erase the entire program:	To add another track to the program:
<p>DISPLAY CANCEL</p>		<p>Repeat step 2.</p>

To exit from Program Play

Before or after playback...

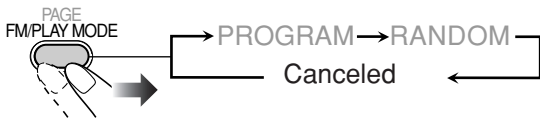

Playing at Random—Random Play



You can play all chapters or tracks at random.

- Random Play cannot be used for DVD-VR/JPEG/MPEG-1/MPEG-2/ASF/DivX and some DVDs.

1 Before starting playback, activate Random Play.

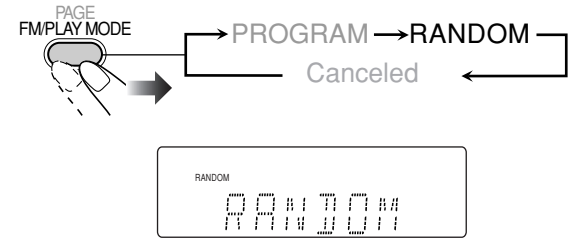

2 Start playback.



Playback starts in random order. Random Play ends when the entire disc has been played.

To skip a chapter/track:	To pause:	To stop:
<p>To go to the beginning of the current track, press ◀◀.</p>	<p>To release, press DVD/CD ▶.</p>	

To exit from Random Play

Before or after playback...

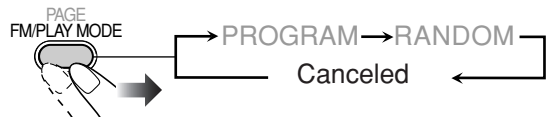

Playing Repeatedly



- You can also select the repeat mode using the on-screen bar (see pages 24 and 25).
- For MP3/WMA/JPEG/MPEG-1/MPEG-2/ASF/DivX, see page 28.

Repeat Play

You can repeat playback.

- **For DVD Video/Audio:**
While playing...

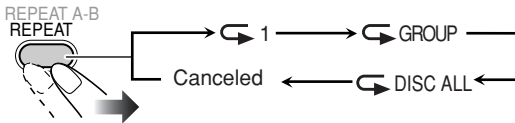

- **For CD/SVCD/VCD:**

While playing (without PBC for SVCD/VCD) or before playback...

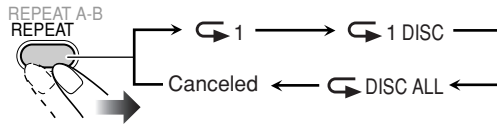

- **For DVD-VR:**

While playing an original program...



While playing a playlist...

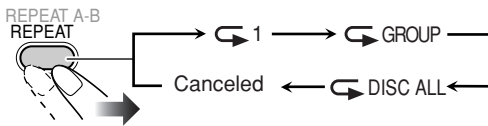

↶, 1	Repeats the current chapter/track.
↶. GROUP	Repeats the current title (for DVD Video)/group (for DVD Audio)/title of PG or PL (for DVD-VR).
↶, 1, DISC	Repeats the current disc.
↶, DISC, ALL	Repeats all discs.

A-B Repeat

You can repeat playback of a desired portion by specifying the beginning (point A) and the ending (point B).

- A-B Repeat cannot be used for MP3/WMA/MPEG-1/MPEG-2/ASF/DivX and for some DVDs.

- 1 While playing (without PBC for SVCD/VCD), select the start point (A).

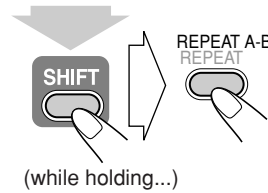

↶A- appears on the display.

- ↶A- appears on the TV if the TV is turned on.

- 2 Select the end point (B).

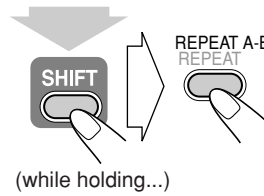

↶A-B appears on the display.

- ↶A-B appears on the TV.
- You can search for the end point using the ►► button.

To cancel A-B Repeat, press REPEAT A-B again while holding SHIFT.

- A-B Repeat will also be canceled when you stop play or skip the chapter or track.

Prohibiting Disc Ejection—Child Lock



You can lock the disc trays so that no one can eject the loaded disc.

- This is possible only while the System is on standby.

While the disc trays are closed...

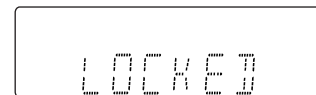
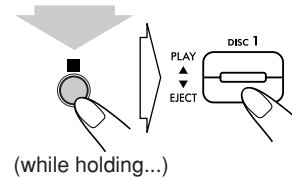

To cancel the prohibition, repeat the same procedure. “UNLOCKED” appears on the display.

On-screen Disc Operations

You can check the disc information and use some functions through the on-screen bar.

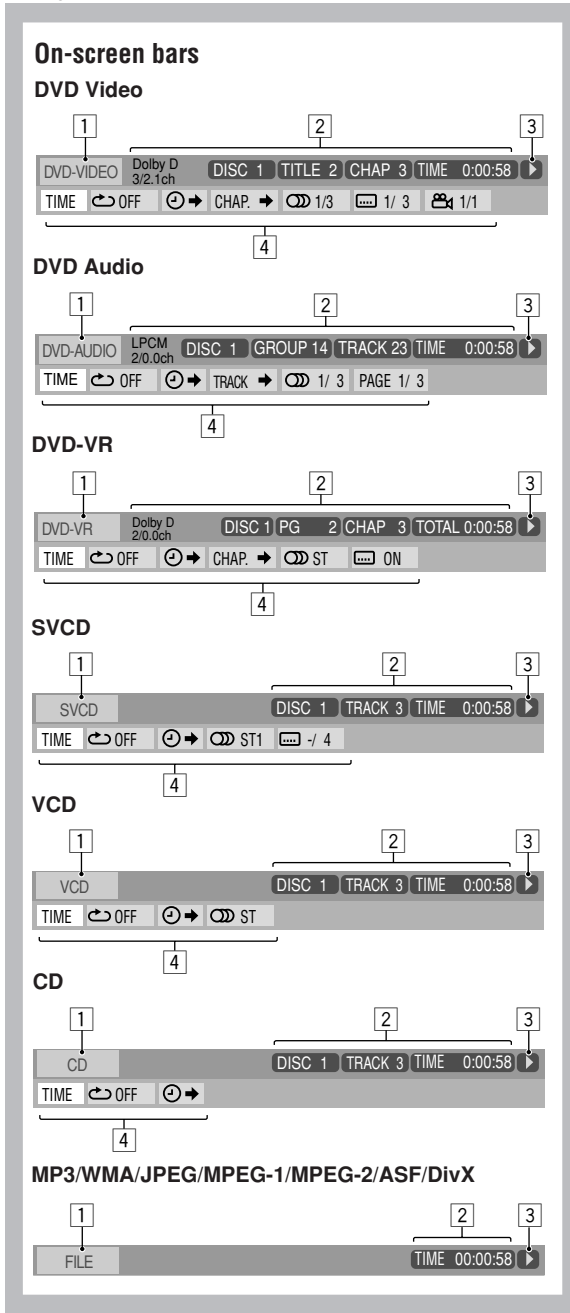

On-screen bars

DVD-VIDEO

1: Format (Dolby D 3/2.1ch) | 2: Disc/Title/Chapter (DISC 1 TITLE 2 / CHAP 3) | 3: Time (0:00:58) | 4: Function icons (TIME, OFF, CHAP, 1/3, 1/3, 1/1)

DVD-AUDIO

1: Format (LPCM 2/0.0ch) | 2: Disc/Group/Track (DISC 1 GROUP 14 / TRACK 23) | 3: Time (0:00:58) | 4: Function icons (TIME, OFF, TRACK, 1/3, PAGE 1/3)

DVD-VR

1: Format (Dolby D 2/0.0ch) | 2: Disc/Program/Chapter (DISC 1 PG 2 / CHAP 3) | 3: Total Time (TOTAL 0:00:58) | 4: Function icons (TIME, OFF, CHAP, ST, ON)

SVCD

1: Format (SVCD) | 2: Disc/Track (DISC 1 TRACK 3) | 3: Time (0:00:58) | 4: Function icons (TIME, OFF, ST1, - / 4)

VCD

1: Format (VCD) | 2: Disc/Track (DISC 1 TRACK 3) | 3: Time (0:00:58) | 4: Function icons (TIME, OFF, ST)

CD

1: Format (CD) | 2: Disc/Track (DISC 1 TRACK 3) | 3: Time (0:00:58) | 4: Function icons (TIME, OFF)

MP3/WMA/JPEG/MPEG-1/MPEG-2/ASF/DivX

1: Format (FILE) | 2: Time (00:00:58) | 3: Time (00:00:58)

On-screen Bar Information

1 Disc type

2 Playback information

Indication





Meanings

Dolby D, LPCM	Audio format
3/2.1ch, 2/0.0 ch	Channel number
DISC 1	Current disc
TITLE 2	Current title
CHAP 3	Current chapter
GROUP 1	Current group
PG 2	Current title of original program
PL 2	Current title of playlist
TRACK 14	Current track
TOTAL 1:25:58	Time indications

3 Operation modes

Indication





Meanings

	Playback
	Forward/Reverse search
	Forward/Reverse slow-motion
	Pause
	Stop

4 Function icons (on the pull-down menu)

Indication

Meanings

TIME	Select to change the time indication.
	Select to repeat playback.
	Select for time search.
CHAP. →	Select for chapter search.
TRACK →	Select for track search.
	Select to change the audio language or channel (see also page 17).
	Select to change subtitle language (see also page 18).
	Select to change the view angle (see also page 18).
PAGE 1 / 5	Select to change the page (see also page 18).

To operate using the On-screen Bar

Ex.: Selecting a subtitle (French) for DVD Video

While a disc is selected as the source...

1 Display the entire on-screen bar.

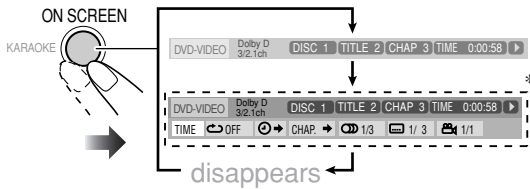

* This does not appear for MP3/WMA/JPEG/MPEG-1/MPEG-2/ASF/DivX discs.

2 Select (highlight) the item you want.

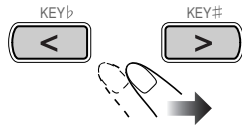

3 Display the pop-up window.



4 Select the desired option in the pop-up window.

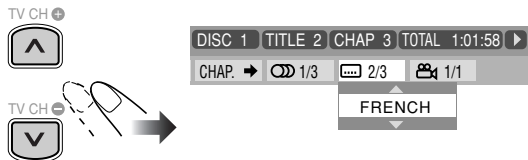

5 Finish the setting.

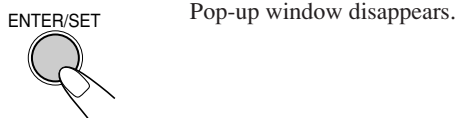

To remove the on-screen bar



For detailed operations of the following functions, see also “To operate using the On-screen Bar” on the left.

To change the time information

You can change the time information in the on-screen bar and the display window on the main unit.

1 While playing, display the on-screen bar with the pull-down menu.



2 Make sure [TIME] is selected (highlighted).

3 Change the time indication.

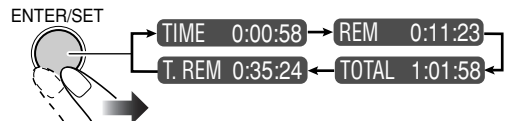

TIME	Elapsed playing time of the current chapter/track (except for DVD-VR).
REM	Remaining time of the current chapter/track (except for DVD-VR).
TOTAL	Elapsed disc time.
T.REM	Remaining disc time.

To remove the on-screen bar



Repeat Play

• See also page 22.

1 While playing a disc (without PBC for SVCD/VCD), display the entire on-screen bar.

• Repeat Play can be selected before starting playback, except for DVD Video/DVD-VR.

2 Select [OFF].

3 Display the pop-up window.



4 Select the repeat mode you want.

A-B	Repeats a desired portion (see below).
TITLE	Repeats the current title.
GROUP	Repeats the current group.
DISC	Repeats the current disc.
ALL	Repeats all discs (except for DVD).
CHAPTER*	Repeats the current chapter.
TRACK*	Repeats the current track.
PG	Repeats the current title of original program (for DVD-VR only) (see also page 22).
PL	Repeats the current title of playlist (for DVD-VR only) (see also page 22).
OFF	Cancels Repeat Play.

*During Program Play and Random Play, “STEP” appears.

5 Finish the setting.

ENTER/SET



A-B Repeat

• See also page 22.

1 While playing, display the entire on-screen bar.

2 Select [OFF].

3 Display the pop-up window.



4 Select “A-B.”

TV CH

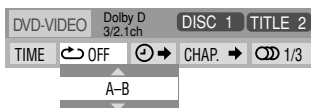

5 Select the start point (A).

ENTER/SET



6 Select the end point (B).

ENTER/SET



A-B Repeat starts. The selected portion plays repeatedly.
 • Before pressing ENTER/SET, you can search for the end point using the ►► button.

To cancel A-B Repeat, repeat steps 1 to 3, and select “OFF” in step 4.

Time Search

You can move to a particular point by specifying the elapsed playing time from the beginning.

1 While playing (without PBC for SVCD/VCD), display the entire on-screen bar.

- Time Search can be used before starting playback, except for DVD Video/DVD-VR.

2 Select [TIME].

3 Display the pop-up window.



4 Enter the time.

You can specify the time in hours/minutes/seconds.



Examples:

To move to a point of 1 (hours): 02 (minutes): 00 (seconds), press 1, 0, 2, 0, then 0.

To move to a point of 54 (minutes): 00 (seconds), press 0, 5, 4, 0, then 0.

- It is always required to enter the hour digit (even “0” hour), but it is not required to enter trailing zeros (the last two digits in the examples above).
- To correct a mis-entry, press Cursor < to erase the last entry.

5 Finish the setting.

ENTER/SET



The System starts playing the disc from the selected playing time.

Chapter/Track Search

You can search for the chapter (DVD Video/DVD-VR) or track (DVD Audio) number to play.

1 While playing, display the entire on-screen bar.

2 Select [CHAPTER] or [TRACK].

3 Display the pop-up window.

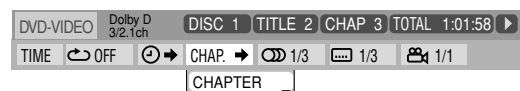

4 Enter the desired chapter/track number.



Examples:

- To select chapter/track 5, press 5.
- To select chapter/track 10, press 1, then 0.
- To select chapter/track 15, press 1, then 5.
- To select chapter/track 30, press 3, then 0.

- To correct a mis-entry, press the number keys until the desired number shown in the pop-up window.

5 Finish the setting.

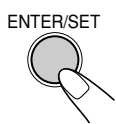

The System starts playing the searched chapter or track.

Browsable Still Pictures

- See also page 18.

For DVD Audio only: While playing back a track linked to browsable still pictures (B.S.P.), you can select the still picture (turn the page) to be shown on the TV.

- If a track is linked to browsable still pictures (B.S.P.), they are usually shown automatically during playback.

1 While playing a DVD Audio, display the entire on-screen bar.

2 Select PAGE 1/5 .

3 Display the pop-up window.

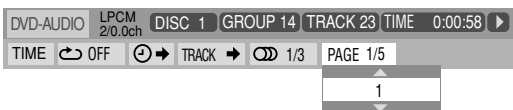

4 Select a still picture you want.

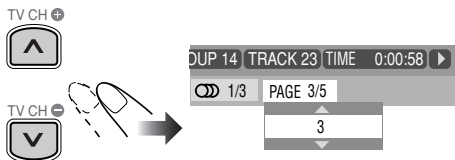

5 Finish the setting.



Control screen for DVD-R/-RW in DVD-VR format

The control screen is superimposed on the TV screen when you call up Program List (PG) or playlist (PL).

To select playback type

To select the Program List:	To select the playlist:
To remove the list, press the same button again.	

Ex.: When Program List is selected.

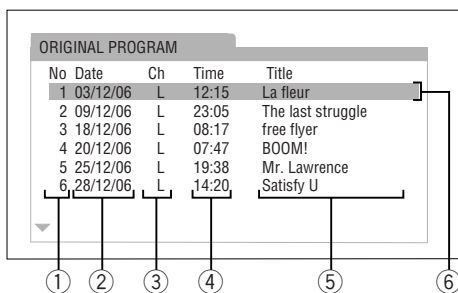

Ex.: When playlist is selected.

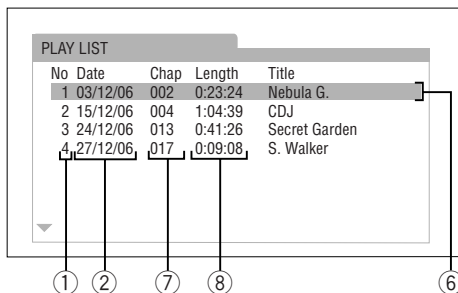

- ① Listed number
- ② Recording date
- ③ Recording channels
- ④ Recording time
- ⑤ Title
- ⑥ Highlight bar (current selection)
- ⑦ Chapters included
- ⑧ Playback time

To select an item in the list and start playback

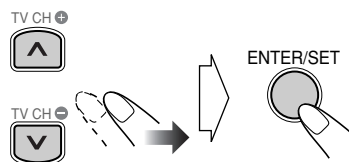

Operations on the Control Screen

You can search for and play the desired items through the control screen for MP3/WMA/JPEG/MPEG-1/MPEG-2/ASF/DivX discs.

Control screen for MP3/WMA/JPEG/MPEG-1/MPEG-2/ASF/DivX discs

The control screen automatically appears on the TV screen when you load an MP3, WMA JPEG, MPEG-1, MPEG-2, ASF or DivX disc.

Ex.: When the MP3 disc is loaded.

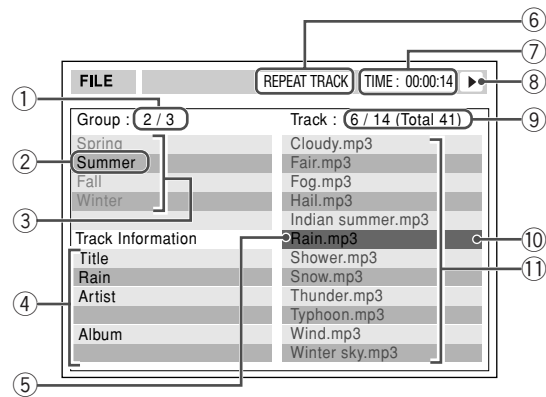

- ① Current group number/total group number
- ② Current group
- ③ Group list
- ④ Track information (ID3 Tag Version 1.0: only for MP3/WMA)
- ⑤ Current track
- ⑥ Repeat Play setting
- ⑦ Elapsed playing time of the current track (except for JPEG)
- ⑧ Operation mode icon
- ⑨ Current track number/total number of tracks in the current group (total number of tracks on the loaded disc)
- ⑩ Highlight bar
- ⑪ Track list

- If files of different types (MP3, WMA, JPEG, MPEG-1, MPEG-2, ASF and DivX) are recorded on a disc, select the file type to play (see page 36).

To move the highlight bar between group list and track list

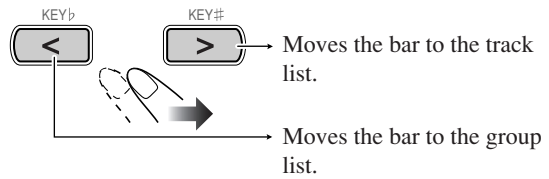

To select an item in the list

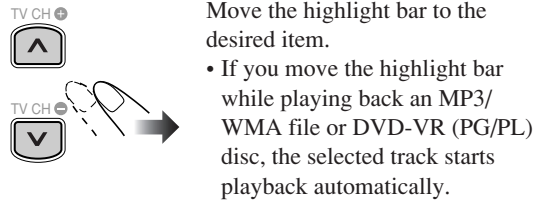

Move the highlight bar to the desired item.

- If you move the highlight bar while playing back an MP3/WMA file or DVD-VR (PG/PL) disc, the selected track starts playback automatically.

To start playback

For JPEG:	
	The selected track (still picture) is displayed until you change it.
	Slide-show playback starts. Each track (still picture) is shown on the screen for about 3 seconds, then changes one after another.
For the other files:	
	Playback starts with the selected track. <ul style="list-style-type: none"> • Pressing DVD/CD ► also starts playback.

- Once you start playing back a JPEG/MPEG-1/MPEG-2/ASF/DivX track, the control screen disappears.
- To cancel slide-show and display the current still picture, press **II**.

To select a group (for MP3/WMA/JPEG/MPEG-1/MPEG-2/ASF/DivX):

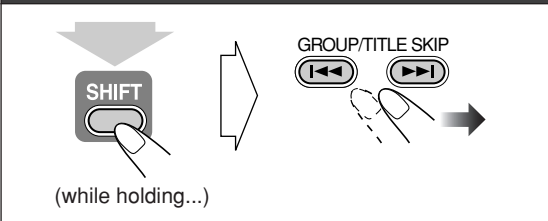

To skip a track:



To stop playback:



- You can select a group directly by pressing a number button after pressing GROUP/TITLE (except for DVD-VR disc).

To repeat MP3/WMA playback

While playing or before playback...



To repeat slide-show for JPEG

While playing or before playback...

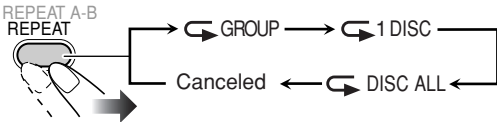

To repeat MPEG-1/MPEG-2/ASF/DivX playback

While playing or before playback...

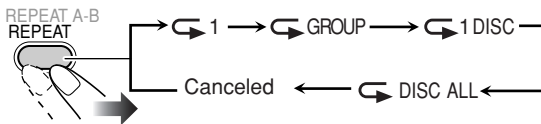

1	Repeats the current track.
.GROUP	Repeats the current group.
,1,DISC	Repeats the current disc.
,DISC,ALL	Repeats all discs.

To zoom in the JPEG files

- You cannot zoom in the still picture during slide-show.
- For other discs, see page 19.

1 While playing back a still picture...

- During slide-show, press **II** to display the still picture, then...

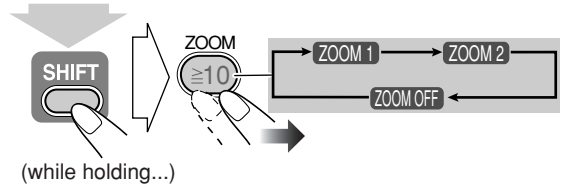

2 Move the zoomed-in position.

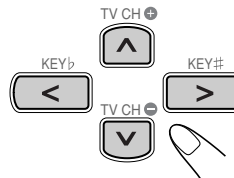

To cancel Zoom, press ZOOM (while holding SHIFT) repeatedly until “ZOOM OFF” appears on the TV.

Advanced Tape Operations

Remote control

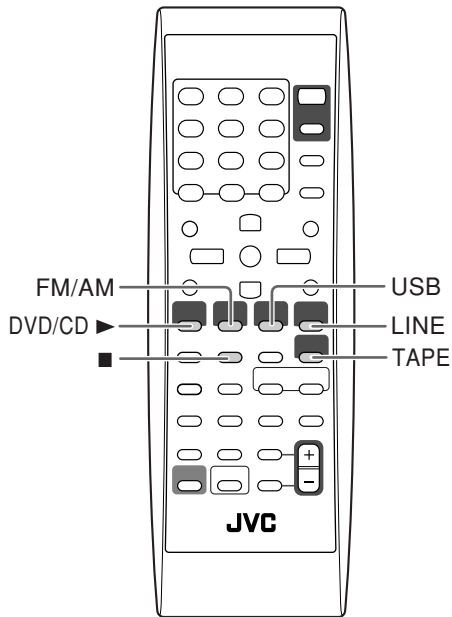

Main unit

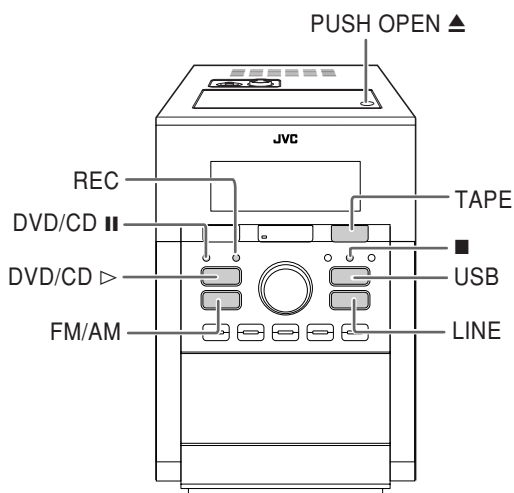

IMPORTANT

It may be unlawful to record or playback copyrighted material without the consent of the copyright owner.

Recording on a Tape **INFO**

You can use type I tapes for recording.

- To play a tape, see page 9.

1 Insert a recordable cassette.

Push Insert Close

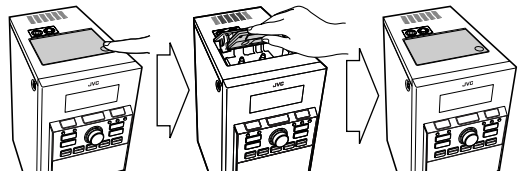

With the tape side facing outside

2 Select and start playing the source—"FM," "AM," "DVD/CD," "USB," or "LINE."

- When recording a disc, you can also use "Synchronized Disc Recording" (see page 30).

3 Start recording.



On the main unit

To stop recording:



Synchronized Disc Recording INFO

You can start and stop both disc play and tape recording at the same time.

To record the entire disc

1 Load a disc and insert a recordable cassette.

- If the current playing source is not the disc player, press DVD/CD ►, then ■.

2 Start recording.



The System automatically creates 4-second blanks between the tunes recorded on the tapes.

On the main unit

- When either disc play* or recording ends, both disc player and the cassette deck stop at the same time.
- * For DVD Video: When a title is finished playing.

To record Program Play

- 1 Select Program Play (and make a program), but do not start playback.
 - 2 Press REC to start recording.
- When disc play stops, recording stops automatically.

To record only your favorite track

You can specify tracks to be recorded on the tape while listening to a disc (except for DVD Video/DVD-VR).

1 Start playing a disc.



2 While a track you want to record on the tape is playing...



On the main unit

The disc player returns to the beginning of that track and the track is recorded on the tape. After recording the track, the disc player and cassette deck automatically stop.

3 Repeat steps 1 and 2 to record other tracks you want.

- You can change the disc if necessary.

To protect your recording

Cassettes have two small tabs on the back to protect from unexpected erasure or re-recording.

To protect your recording, remove these tabs.



To re-record on a protected tape, cover the holes with adhesive tape.

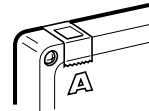

Enjoying Karaoke

Remote control

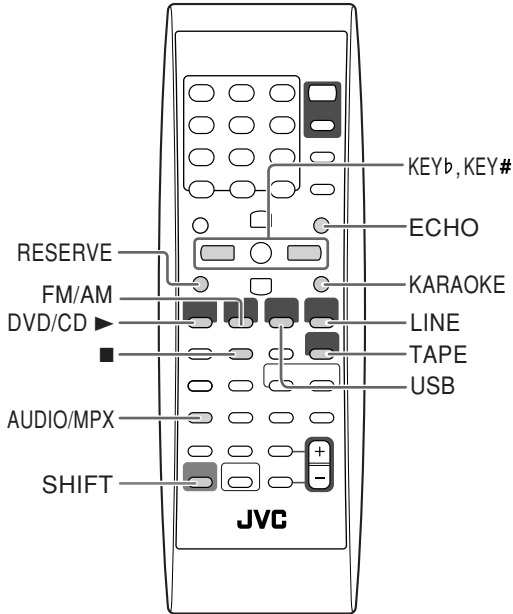

Main unit

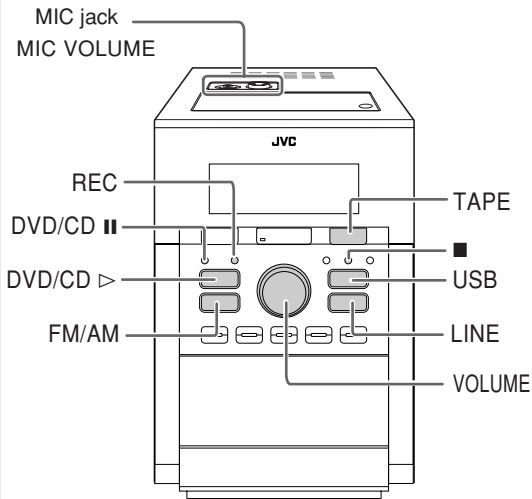

IMPORTANT

Always set MIC VOLUME to MIN when connecting or disconnecting the microphone.



DO NOT keep the microphone connected while they are not in use.

Singing Along (Karaoke) INFO

To sing along using the Karaoke discs

You can enjoy Karaoke using the Karaoke disc (except Karaoke CD).

- By pressing REC, you can record your singing-along (for SVCD/VCD without PBC).

1 Turn MIC VOLUME to MIN.

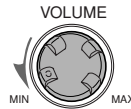

2 Connect the microphone (not supplied) to the MIC jack.

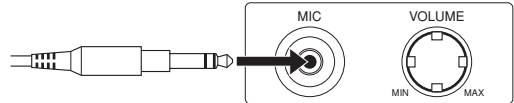

3 Insert and start playing a Karaoke disc.

4 Select an audio track.



- For details, see “Selecting the Audio Track” on page 17.

5 Sing into the microphone.

6 Adjust the MIC VOLUME and VOLUME.



To adjust the Key (disc playback only)

1 Activate Key Control.

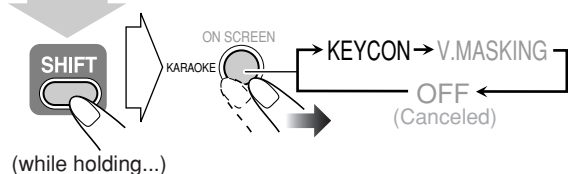

2 Adjust the Key

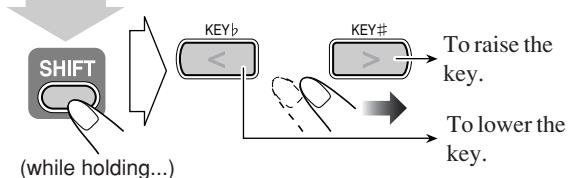

- Key Control cannot be activated for DVD Audio/ DVD-VR/MPEG-1/MPEG-2/ASF/DivX.

To deactivate Key Control, press KARAOKE (while holding SHIFT) to select “OFF.”

To apply echo to your voice

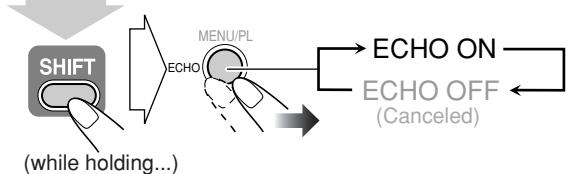

To sing along using the stereo discs —Vocal Masking

You can enjoy Karaoke while playing a stereo disc. Vocal Masking reduces the lead vocal of any disc except DVD Audio and DVD-VR.

1 Turn MIC VOLUME to MIN.

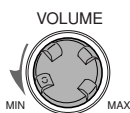

2 Connect the microphone (not supplied) to the MIC jack.

3 Insert and start playing a stereo disc.



4 Activate Vocal Masking.

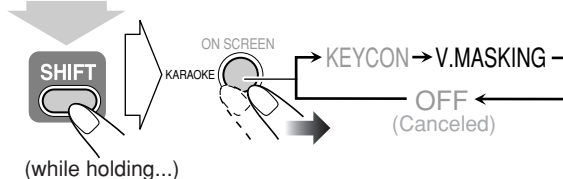

5 Sing into the microphone.

6 Adjust the MIC VOLUME and VOLUME.



- You can apply echo to your voice.

To deactivate Vocal Masking, select “OFF” in step 4.

Microphone Mixing ●●●●●●●●●●

You can enjoy microphone mixing while playing any source.

- By pressing REC, you can record your singing-along (except when the playing source is “TAPE”).

1 Turn MIC VOLUME to MIN.

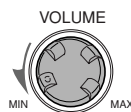

2 Connect the microphone (not supplied) to the MIC jack.

3 Start playing the source—“FM,” “AM,” “DVD/CD,” “USB,” “TAPE,” or “LINE.”

4 Sing into the microphone.

5 Adjust the MIC VOLUME and VOLUME.



- You can apply echo to your voice. While playing a disc, you can also adjust Key Control and apply echo.

Reserving Karaoke Songs



—Karaoke Program Play

You can determine the playback order of the titles or tracks on the disc player. You can program up to 12 steps.

1 Change the source to “DVD/CD.”

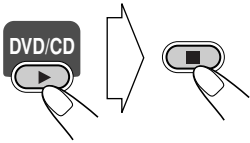

2 Activate Karaoke Program Play.

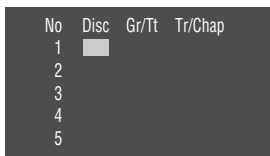
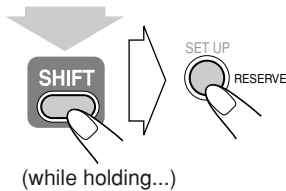

On the TV screen

• PRGM indicator flashes during this mode.

3 Select songs you want for Karaoke Program Play.

Press the number buttons to select a song in the following order.

- ① Select a disc.
- ② Select a title/group.
- ③ Select a chapter/track.



Examples:

- To select number 5, press 5.
- To select number 10, press 10.
- To select number 15, press ≥10, 1, then 5.
- To select number 30, press ≥10, 3, then 0.

4 Start playback.



Playback starts in the order you have programmed.

To check the programmed contents

During Karaoke Program Play...

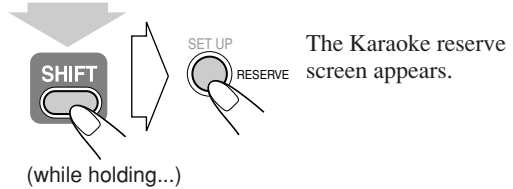

To modify the program

While the Karaoke reserve screen is shown on the TV...

To remove the unwanted track:

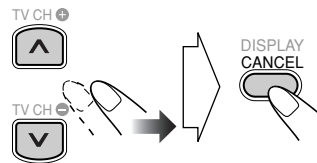

To add another track to the program:

Repeat step 3.

To erase the entire program:

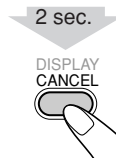

To exit from Karaoke Program Play

Before or after playback...

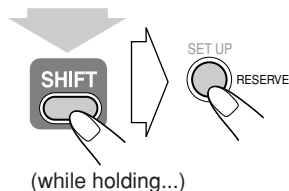

During playback...

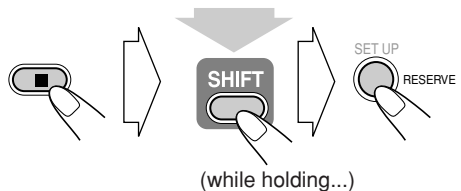

Timer Operations

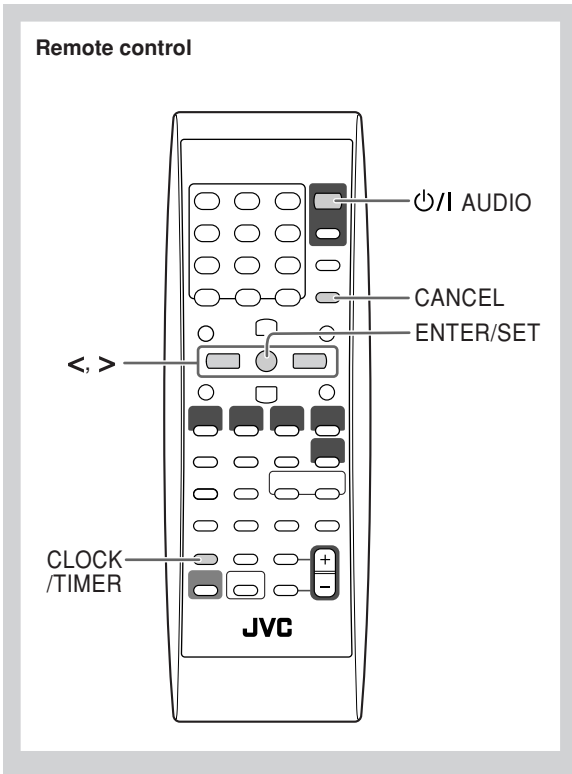

- 1 Select one of the timer setting modes you want to set—**REC TIMER** (Recording Timer) ON time, **DAILY 1 ON** time, **DAILY 2 ON** time or **DAILY 3 ON** time.

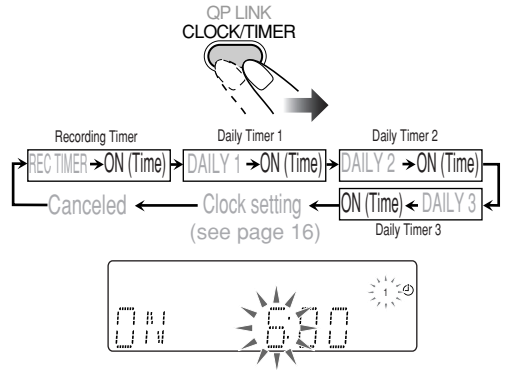

Ex. When Daily Timer 1 setting mode is selected

- When the clock has not been set, pressing **CLOCK/TIMER** makes the System enter the clock setting mode.

- 2 Make the timer setting as you want.

Repeat the procedure for the following settings until finished:

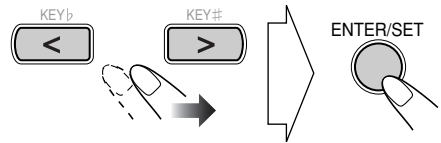

For Recording Timer:

- ① Set the hour then the minute for on-time.
- ② Set the hour then the minute for off-time.
- ③ Select the playback source—"TUNER-FM," "TUNER-AM," or "LINE IN."
- ④ For "TUNER-FM" and "TUNER-AM": Select a preset channel.
- ⑤ Select the volume level.
 - You can adjust the volume level ("0" to "40" and "VOL --").
 - If you select "VOL --," the volume is set to the last level when the unit has been turned off.

For Daily Timers:

- ① Set the hour then the minute for on-time.
- ② Set the hour then the minute for off-time.
- ③ Select the playback source—"TUNER-FM," "TUNER-AM," "TAPE," "DISC," or "LINE IN."

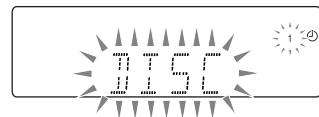

- ④ For "TUNER-FM" and "TUNER-AM": Select a preset channel.

Setting the Timer



Using Daily Timer, you can wake up with your favorite music. On the other hand, with Recording Timer, you can make a tape of a radio broadcast or the sound from LINE IN automatically.

You can store three Daily Timer settings and one Recording Timer setting; however, you can activate only one of the timers at the same time.

- To exit from the timer setting, press **CLOCK/TIMER** as required.
- To correct a mis-entry during process, press **CANCEL**. You can go back to the previous step.

Recording Timer and Daily Timer initial settings when shipped from the factory

- **REC TIMER:** ON Time (6:00)/OFF Time (10:00)/ Source (TUNER FM 1)/Volume level (--)
- **DAILY 1:** ON Time (6:00)/OFF Time (8:00)/ Source (TUNER FM 1)/Volume level (--)
- **DAILY 2:** ON Time (12:00)/OFF Time (14:00)/ Source (TUNER FM 1)/Volume level (--)
- **DAILY 3:** ON Time (18:00)/OFF Time (20:00)/ Source (TUNER FM 1)/Volume level (--)

For “DISC”: Select the disc tray number, the title/group number, then the chapter/track number.

⑤ Select the volume level.

- You can adjust the volume level (“0” to “40” and “VOL --”).

If you select “VOL --,” the volume is set to the last level when the unit has been turned off.

Once settings are complete, the Timer setting information appears in sequence.

- This function is not available for VCD with PBC activated.

3 Turn off the unit (on standby) if you have set the on-time.



How Daily Timer works

Once the Daily Timer has been set, the timer indicator (⊕) and timer number indicator (1/2/3) are lit on the display. Daily Timer is activated at the same time everyday until the timer is turned off manually (see the next column) or another timer is activated.

When the on-time comes

The System turns on, tunes in to the specified station or starts playing the loaded disc with the specified chapter or track, and sets the volume level gradually to the preset level after about 30 seconds.

- While Daily Timer is working, the timer indicator (⊕) and timer number indicator (1/2/3) flash on the display.

When the off-time comes

The System stops playback, and turns off (on standby) automatically.

- The timer setting remains in memory until you change it.

How Recording Timer works

When Recording Timer has been set, Timer (⊕) indicator and the REC indicator are lit on the display. Recording Timer works only once.

When the on-time comes

The System turns on, tunes in to the specified station or changes the source to “LINE”, and starts recording.

When the off-time comes

- The timer setting remains in memory until you change it.

To turn on or off the Timer

Since Daily Timer is activated at the same time everyday, you may need to cancel it on some particular days.

To cancel the Timer

1 Select the Timer (REC TIMER, DAILY 1, DAILY 2, or DAILY 3) you want to cancel.

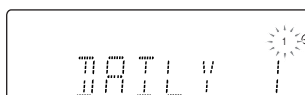
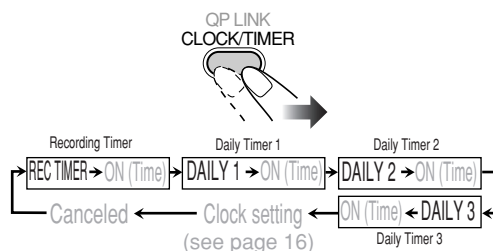

Ex. To cancel Daily Timer 1

2 Turn off the selected Timer.



To turn on the Timer

1 Select the Timer (REC TIMER, DAILY 1, DAILY 2, or DAILY 3) you want to activate.

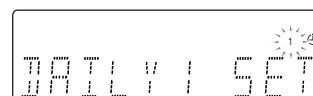
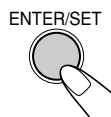
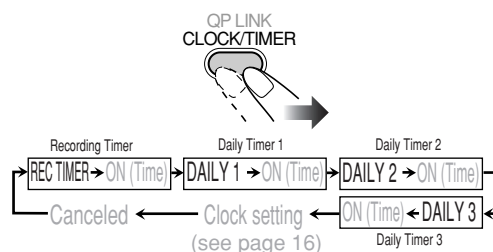

Ex. When Daily Timer 1 (DAILY 1) is activated

3 Wait until the indication disappears.

Setup Menu Operations INFO

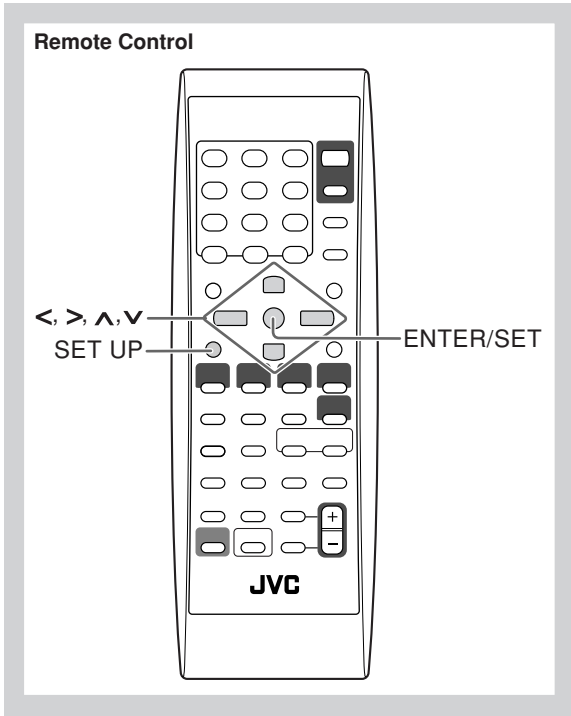

Initial settings Remote ONLY >> ● ● ● ● ● ● ● ●

The Setup Menu cannot be activated during playback.

1 Press SET UP.

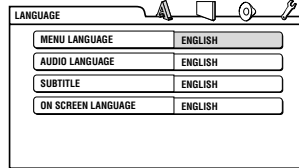

- 2 Press < (or >) to select the menu.
- 3 Press ^ (or v) to select the item.
- 4 Press ENTER/SET.
- 5 Press ^ (or v) to select the options, then press ENTER/SET.

- For settings of the LANGUAGE menu, see also “Language Code List” on page 42.

To remove a preference display
Press SET UP.

A LANGUAGE menu

Item	Contents
MENU LANGUAGE	You can select the initial menu language of the DVD Video.
AUDIO LANGUAGE	You can select the initial audio language of the DVD Video.
SUBTITLE	You can select the initial subtitle language of the DVD Video.
ON SCREEN LANGUAGE	You can select “ENGLISH,” “CHINESE,” or “SPANISH” as the on-screen language.

P PICTURE menu

Item	Contents
MONITOR TYPE 	You can select the monitor type to match your TV when you playback DVD Video discs recorded for wide-screen televisions. 16:9/16:9 MULTI (Wide television screen): For a wide-screen (16:9) TV. 4:3 LB/4:3 MULTI LB (Letter Box conversion): For a conventional (4:3) TV. Displays a wide-screen picture to fit the width of the TV screen keeping the aspect ratio. 4:3 PS/4:3 MULTI PS (Pan Scan conversion): For a conventional (4:3) TV. The picture is zoomed in to fill the screen vertically and the left and right sides of the picture are cut off. • For multi-color system TVs, select the [MULTI] option.
PICTURE SOURCE	You can obtain optimal picture quality by selecting the source type of the disc contents. AUTO: Normally, select this option. The System recognizes the picture type (film or video source) of the current disc according to the disc information. FILM: For a film source disc. VIDEO: For a video source disc.
SCREEN SAVER	You can set the screen saver function to ON or OFF . If no operation is done for about 5 minutes, the display dims.
FILE TYPE	You can select the file type to play. AUDIO: To play MP3/WMA files. STILL PICTURE: To play JPEG files. VIDEO: To play MPEG-1, MPEG-2, ASF and DivX files.



AUDIO menu

Item	Contents
DIGITAL AUDIO OUTPUT	Set this item correctly when using the DVD OPTICAL DIGITAL OUT terminal on the rear. PCM ONLY: When connecting to audio equipment which can decode only linear PCM signals. DOLBY DIGITAL/PCM: When connecting to a Dolby Digital decoder or an amplifier with a built-in Dolby Digital decoder. STREAM/PCM: When connecting to a DTS decoder or an amplifier with a built-in DTS decoder.
DOWN MIX	This setting is effective for digital audio output if “DIGITAL AUDIO OUTPUT” is set to “PCM ONLY.” DOLBY SURROUND: Select this when connecting to a surround decoder. STEREO: Select this when connecting to a stereo receiver, MD player, TV, etc.
D.RANGE COMPRESSION	Set this item to listen to DVD Video recorded in Dolby Digital format at low or middle volume. AUTO: You can enjoy powerful playback sound with full dynamic range. ON: Select this when you want to fully apply the compression effect to make the sound at lower volume clear (useful at midnight).



OTHERS menu

Item	Contents
RESUME	You can select Resume. ON: The System resumes playback from the position where playback has been stopped if the disc is still in the disc tray. OFF: Resume is deactivated.
ON SCREEN GUIDE	Activate or deactivate the on-screen guide.
DivX REGISTRATION	The System has its own Registration Code. If necessary, you can confirm it. Once you have played back a disc in which the Registration Code is recorded, the System's Registration Code is overwritten for copyright protection.

Additional Information

Learning More about This System ● ● ●

Connections (see pages 3 to 5)

- Make sure the antenna conductors do not touch any other terminals, connecting cords or the power cord. Also, keep the antennas away from metallic parts of the System, connecting cords, and the AC power cord. This could cause poor reception.
- Use only speakers with the same speaker impedance as indicated by the speaker terminals on the rear of the System.
- The speakers are magnetically shielded to avoid color distortions on TVs. However, if not installed properly, it may cause color distortions. So, pay attention to the following when installing the speakers.
 - When placing the speakers near a TV set, turn off the TV's main power switch or unplug it before installing the speakers. Then wait at least 30 minutes before turning on the TV's main power switch again.
 - Some TVs may still be affected even though you have followed the above instructions. If this happens, move the speakers away from the TV.
- When a portable audio device is connected to the LINE IN jack, sound will come out of the speakers and headphones. However, no sound will come out of the LINE OUT jack.

Daily Operations—Playback (see pages 7 to 12)

Listening to the Radio:

- If you store a new station into an occupied preset number, the previously stored station in that number will be erased.
- When you unplug the AC power cord or if a power failure occurs, the preset stations will be erased in a few days. If this happens, preset the stations again.

Playing Back a Disc:

- On some DVD, SVCD, or VCD discs, the actual operations may be different from what is explained in this manual, due to the programming and disc structure; such differences are not a malfunction of this System.
- When discs* in more than one tray are loaded on the disc trays, they are played in sequence as follows. (When DVD Video, DVD Audio or SVCD/VCD with PBC is loaded in the System, playback of the disc next to these discs will not start.):

Ex.: When DISC 2 is selected:

DISC 2⇒DISC 3⇒DISC 4⇒DISC 5⇒DISC 1⇒
(then stops)

- * When no disc is loaded on the disc tray, that disc number is skipped.

- You can exchange discs while playing or selecting another disc.
- Some DVD Audio discs prohibit downmix. When you playback such a disc, “LR ONLY” appears on the display and the System plays back the left front and right front signals.
- When playing back a DVD Audio disc recorded in MLP (Meridian Lossless Packing; a lossless audio compression system that can completely recreate the PCM signal), the signals are recognized as the linear PCM signals, however, no indicator lights up on the display.
- This System can recognize up to 4 000 tracks in a disc. Also, the System can recognize up to 150 tracks per group and up to 99 groups in a disc.
 - If there are any unplayable files in a folder, those files are also counted in the total file number.
 - Playable files which do not belong to any groups are handled as Group 1.
- For DVD-VR playback...
 - This System can play only a disc of UDF-Bridge format.
 - For details about DVD-VR format and playlist, refer to the manual of the recording equipment.
 - You cannot use reverse slow motion, Program Play, or Random Play.
- For MP3/WMA playback...
 - MP3/WMA discs require a longer readout time than regular CDs. (It depends on the complexity of the group/file configuration.)
 - Some MP3/WMA files cannot be played back and will be skipped. This results from their recording processes and conditions.
 - This System can play only a disc of ISO 9660 Level 1 or Level 2.
 - This System can playback MP3/WMA files with the extension code <.mp3> or <.wma> (regardless of the letter case—upper/lower).
 - It is recommended that you make each MP3/WMA file at a sampling rate of 44.1 kHz and at a bit rate of 128 kbps. This System cannot playback files made at a bit rate of less than 64 kbps.
- For JPEG files playback...
 - It is recommended that you record a file at 640 x 480 resolution. (If a file has been recorded at a resolution of more than 640 x 480, it will take a long time to be shown.)
 - This System can play only baseline JPEG files*. Progressive JPEG files* or lossless JPEG files* cannot be played.
 - * Baseline JPEG format: Used for digital cameras, web, etc.
 - Progressive JPEG format: Used for web.
 - Lossless JPEG format: An old type and rarely used now.

- This System can playback JPEG files with the extension code <.jpg> or <.jpeg> (regardless of the letter case—upper/lower).
- This System may not playback JPEG files properly if they are recorded on a device other than a digital still camera.
- During slide-show playback, zoom cannot be operated.
- For MPEG-1/MPEG-2 playback...
 - The stream format should conform to MPEG system/program stream.
 - 720 x 576 pixels (25 fps)/720 x 480 pixels (30 fps) is recommended for the highest resolution.
 - This System also supports the resolutions of 352 x 576/480 x 576/352 x 288 pixels (25 fps) and 352 x 480/480 x 480/352 x 240 pixels (30 fps).
 - The file format should be MP@ML (Main Profile at Main Level)/SP@ML (Simple profile at Main Level)/MP@LL (Main Profile at Low Level).
 - Audio streams should conform to MPEG1 Audio layer-2 or MPEG2 Audio Layer-2.
- For ASF playback...
 - This System can play back ASF files with the extension code <.asf> (regardless of the letter case—upper/lower).
 - This System supports ASF files whose resolution is 352 x 288 pixels or less.
 - Some recorded files may not be able to playback depending on file characteristics, kind of digital camera/video camera, or recording conditions.
 - You cannot use the following functions—One Touch Replay, Slow motion, A-B Repeat, Program Play and Random Play.
- For DivX playback...
 - This System can play only a disc of UDF-Bridge format. “Multi-border” is not supported.
 - The System supports DivX files whose resolution is 720 x 480 pixels or less (30 fps), and 720 x 576 pixels or less (25 fps).
 - Audio stream should conform to MPEG1 Audio Layer-2 or MPEG Audio Layer-3 (MP3).
 - This System can play back DivX files with the extension code <.divx> <.div> <.avi> (regardless of the letter case—upper/lower).
 - The System does not support GMC (Global Motion Compression).
 - The file encoded in the interlaced scanning mode may not be played back correctly.
 - You cannot use the following functions—One Touch Replay, Slow motion, A-B Repeat, Program Play, Random Play and on-screen operations.

Playing Back a Portable Audio Device:

- When QP Link fails due to a weak sound signal from the LINE IN jack, Auto Standby may turn the System off even if you can hear the sound from the speakers.

In such cases, adjust the volume level of the component louder so that the System can detect the sound signal properly.

- Changing from LINE to another source while QP Link works will deactivate QP Link temporarily. In this case, the following reactivates QP Link:
 - Pressing QP LINK on the remote control.
 - Unplugging the component from the LINE IN jack, then plugging it again.
- If you press STANDBY  to turn the System off or if preset Timer turns the System off while QP Link works, the System will deactivate QP Link temporarily. In such cases, the following reactivates QP Link:
 - When no sound signal comes from the LINE IN jack for about 30 seconds after the System is turned off.
 - When you turn on the power again.
- QP Link may start working when you just plug in the component to the LINE IN jack or unplug it. This is not a malfunction.

Playing Back from the PC:

- Check if your PC equipped with the CD-ROM drive is running on Windows® 98*, Windows® 98SE*, Windows® Me*, Windows® 2000*, or Windows® XP* and prepare its CD-ROM.
 - *Microsoft®, Windows® 98, Windows® 98SE, Windows® Me, Windows® 2000 and Windows® XP are registered trademarks of Microsoft corporation.
- DO NOT turn off the System or disconnect the USB cable while installing the drivers or until your PC has recognized the System.
- Use a full speed USB cable (version 1.1).
- If your PC does not recognize the System, disconnect the USB cable and connect it again. If this does not work, restart Windows.
- The drivers installed can be recognized only when the USB cable is connected between the System and your PC.
- The sound may not be played back correctly—interrupted or degraded—due to your PC settings or PC specifications.

Daily Operations—Sound & Other Adjustments

(see pages 13 to 16)

Adjusting the Sound:

- This function also affects the sound through the headphones.

Changing the Scanning Mode:

- You cannot change the scanning mode to progressive in the following cases:
 - When your TV does not support the progressive video input.
 - When you have not connected your TV to the system using a component video cord.

Setting the Clock:

- “0:00” will flash on the display until you set the clock.
- The clock may gain or lose 1 to 2 minutes per month. If this happens, reset the clock.

Unique DVD/VCD Operations (see pages 17 to 19)

Selecting the Audio Track:

- On some DVD Video discs, you cannot change audio languages while playing back.

Special Effect Playback:



- During slow-motion playback, no sound will be reproduced.
- While zoomed in, the picture may look coarse.

Advanced Disc Operations (see pages 20 to 28)

Programming the Playing Order—Program Play:

- While programming steps...
 - You cannot eject any discs from the disc trays.
 - Your entry will be ignored if you have tried to program an item number that does not exist (for example, selecting track 14 on a disc that only has 12 tracks).

Playing Repeatedly:

- When DVD Video or DVD Audio is loaded in this System, playback of the disc next to the DVD Video or DVD Audio will not start, although  ALL /REPEAT ALL on the TV screen or  ALL in the display window is shown.
- A-B Repeat can be used within the same title while playing a DVD Video, and within the same track for the other discs.

On-screen Disc Operations:

- For DVD-R/-RW in the VR format, “PG” or “PL” appears instead of “TITLE” on the on-screen bar.

Operations on the Control Screen:

- If you press ON SCREEN on the remote control during playback, playback information appears on the TV screen.

Advanced Tape Operations (see pages 29 and 30)

Recording on a Tape:

- The recording level is automatically set correctly. Thus, you can adjust the sound you are actually listening to without affecting the recording level.
- There is leader tape which cannot be recorded onto at the start and end of cassette tapes. Thus, when recording CDs or radio broadcasts, wind the leader tape first to ensure that the recording will be made without any music part lost.
- If you start recording with no cassette inserted, “NO REC” appears on the display. If a protected tape has been inserted, “NO REC” appears.
- You cannot open or close the disc tray while recording a disc.

Synchronized Disc Recording:

- Synchronized recording does not function on the file format of MPEG-1, MPEG-2, ASF, and DivX.

Enjoying Karaoke (see pages 31 to 33)

Singing Along (Karaoke):

- Karaoke mode setting (Key Control and Vocal Masking) can be used when selecting “DVD/CD” as the source, except for DVD-VR/DVD Audio/MPEG-1/MPEG-2/ASF/DivX discs.

- Even if the source is “DVD/CD,” Karaoke mode setting cannot be used while “NO DISC” appears on the display.
- Karaoke mode setting is automatically canceled when the source is changed.
- Even when the microphone is not used, Key Control and Vocal Masking are available.
- Karaoke mode setting is also applied to the optical digital output signals.
- When Vocal Masking is activated, 3D Phonic will be canceled temporarily.
- On some music discs, Vocal Masking does not provide the correct effect.
- You can also use the microphone when selecting the source other than “DVD/CD.”

Timer Operations (see pages 34 and 35)

Setting the Timer:

- If you do not specify the preset station or track number correctly while setting a timer, the currently selected station or the first track will be played when the timer is activated.
- When you unplug the AC power cord or if a power failure occurs, the timer will be canceled. You need to set the clock first, then the timer again.
- If you set DVD Video as the source, Daily Timer will not work correctly.

Timer Priority:

- If you set the Sleep Timer after Daily Timer starts playing the selected source, Daily Timer is canceled.

Setup Menu Operations (see pages 36 and 37)

General:

- If the upper and lower parts of the menu are cut off, adjust the picture size control of the TV.

LANGUAGE menu:

- When the language you have selected for MENU LANGUAGE, AUDIO LANGUAGE, or SUBTITLE is not recorded on a disc, the original language is used as the initial language.

PICTURE menu—MONITOR TYPE:

- Even if “4:3 PS/4:3 MULTI PS” is selected, the screen size may become 4:3 letter box while playing a disc. This depends on how the discs are recorded.
- When you select “16:9/16:9 MULTI” for a picture whose aspect ratio is 4:3, the picture slightly changes due to the process for converting the picture width.

OTHERS menu—ON SCREEN GUIDE:

- The setup menu and on-screen bar will be displayed (and recorded) even though this function is set to “OFF.” Subtitles and the information for zoom-in always appear on the display regardless of this setting.

Troubleshooting

General:

Adjustments or settings are suddenly canceled before you finish.

⇒ There is a time limit. Repeat procedure again.

Operations are disabled.

⇒ The built-in microprocessor may malfunction due to external electrical interference. Unplug the AC power cord and then plug it back in.

Unable to operate the System from the remote control.

⇒ The path between the remote control and the remote sensor on the System is blocked.

⇒ The batteries are exhausted.

No sound is heard.

⇒ Speaker connections are incorrect or loose.

⇒ Headphones are connected.

No picture appears on the screen.

⇒ The video cord connections are incorrect or loose.

No picture is displayed on the TV screen, the picture is blurred, or the picture is divided into two parts.

⇒ The System is connected to a TV which does not support progressive video input.

The left and right edges of the picture are missing on the screen.

⇒ Select "4:3 LB/4:3 MULTI LB" for "MONITOR TYPE" (see page 36).

Radio Operations:

Hard to hear broadcasts because of noise.

⇒ Antennas connections are incorrect or loose.

⇒ The AM loop antenna is too close to the System.

⇒ The FM antenna is not properly extended and positioned.

Disc Playback Operations:

The disc does not play.

⇒ You have inserted a disc whose Region Code is not correct. ("REGION ERR" appears on the display.)

⇒ The disc is placed upside down. Place the disc with the label side up.

ID3 Tag on an MP3/WMA disc cannot be shown.

⇒ There are two types of ID3 Tag—Version 1 and Version 2. This System can only show ID3 Tag Version 1.

Groups and tracks are not played back as you expect.

⇒ The playing order is determined when the groups and tracks were recorded. It depends on the writing application.

MP3, WMA, JPEG, MPEG-1, MPEG-2, ASF or DivX files are not played back.

⇒ The disc may include different types of tracks (MP3/WMA files, JPEG files and MPEG-1/MPEG-2/ASF/DivX files). In this case, you can only playback the files selected by the "FILE TYPE" setting (see page 36).

⇒ You have changed the "FILE TYPE" setting after the System read the disc. In this case, reload the disc.

"NO AUDIO" appears.

⇒ This System cannot playback illegally produced DVD Audio discs.

"LR ONLY" appears.

⇒ Some DVD Audio discs prohibit downmixed output.

When you playback such a disc, this System plays back the left front and right front signals only.

The disc sound is discontinuous.

⇒ The disc is scratched or dirty.

No subtitle appears on the display though you have selected the initial subtitle language.

⇒ Some DVDs are programmed to always display no subtitle initially. If this happens, press SUBTITLE after starting playback (see page 18).

Audio language is different from the one you have selected as the initial audio language.

⇒ Some DVDs are programmed to always use the original language initially. If this happens, press AUDIO/MPX after starting playback (see page 17).

The disc tray does not open or close.

⇒ The AC power cord is not plugged in.

⇒ Child Lock is in use. "LOCKED" appears in the display window (see page 22).

Tape Operations:

The cassette holder cannot be opened.

⇒ Power supply from the AC power cord has been cut off while the tape was running. Turn on the System.

USB Operations:

Unable to playback through the USB connection.

⇒ USB connection and setting is incorrect.

Playback stops.

⇒ Disconnect and connect the USB cable again.

⇒ Restart the music software on your PC.

⇒ Turn off and on the System.

Timer Operations:

Daily Timer does not work.

⇒ The System has been turned on when the on-time comes. Timer starts working only when the System is turned off.

Daily Timer does not start playback.

⇒ The disc loaded is a DVD Video. Change the disc.

⇒ Title/group number and chapter/track number are not entered while setting the Daily Timer. Do not skip these steps when you want to play a disc using Daily Timer.

Language Code List

AA	Afar	FA	Persian	KM	Cambodian	OM	(Afan) Oromo	SV	Swedish
AB	Abkhazian	FI	Finnish	KN	Kannada	OR	Oriya	SW	Swahili
AF	Afrikaans	FJ	Fiji	KO	Korean (KOR)	PA	Panjabi	TA	Tamil
AM	Ameharic	FO	Faroese	KS	Kashmiri	PL	Polish	TE	Telugu
AR	Arabic	FY	Frisian	KU	Kurdish	PS	Pashto, Pushto	TG	Tajik
AS	Assamese	GA	Irish	KY	Kirghiz	PT	Portuguese	TH	Thai
AY	Aymara	GD	Scots Gaelic	LA	Latin	QU	Quechua	TI	Tigrinya
AZ	Azerbaijani	GL	Galician	LN	Lingala	RM	Rhaeto-Romance	TK	Turkmen
BA	Bashkir	GN	Guarani	LO	Laothian	RN	Kirundi	TL	Tagalog
BE	Byelorussian	GU	Gujarati	LT	Lithuanian	RO	Rumanian	TN	Setswana
BG	Bulgarian	HA	Hausa	LV	Latvian, Lettish	RW	Kinyarwanda	TO	Tonga
BH	Bihari	HI	Hindi	MG	Malagasy	SA	Sanskrit	TR	Turkish
BI	Bislama	HR	Croatian	MI	Maori	SD	Sindhi	TS	Tsonga
BN	Bengali, Bangla	HU	Hungarian	MK	Macedonian	SG	Sangho	TT	Tatar
BO	Tibetan	HY	Armenian	ML	Malayalam	SH	Serbo-Croatian	TW	Twi
BR	Breton	IA	Interlingua	MN	Mongolian	SI	Singhalese	UK	Ukrainian
CA	Catalan	IE	Interlingue	MO	Moldavian	SK	Slovak	UR	Urdu
CO	Corsican	IK	Inupiak	MR	Marathi	SL	Slovenian	UZ	Uzbek
CS	Czech	IN	Indonesian	MS	Malay (MAY)	SM	Samoan	VI	Vietnamese
CY	Welsh	IS	Icelandic	MT	Maltese	SN	Shona	VO	Volapuk
DA	Danish	IW	Hebrew	MY	Burmese	SO	Somali	WO	Wolof
DZ	Bhutani	JI	Yiddish	NA	Nauru	SQ	Albanian	XH	Xhosa
EL	Greek	JW	Javanese	NE	Nepali	SR	Serbian	YO	Yoruba
EO	Esperanto	KA	Georgian	NL	Dutch	SS	Siswati	ZU	Zulu
ET	Estonian	KK	Kazakh	NO	Norwegian	ST	Sesotho		
EU	Basque	KL	Greenlandic	OC	Occitan	SU	Sundanese		

Maintenance

To get the best performance of the System, keep your discs, tapes and mechanism clean.

Handling discs

- Remove the disc from its case by holding it at the edge while pressing the center hole lightly.
- Do not touch the shiny surface of the disc, or bend the disc.
- Put the disc back in its case after use to prevent warping.
- Be careful not to scratch the surface of the disc when placing it back in its case.
- Avoid exposure to direct sunlight, extreme temperature, and moisture.

To clean the disc:

Wipe the disc with a soft cloth in a straight line from center to edge.

Cleaning the System

- Stains should be wiped off with a soft cloth. If the System is heavily stained, wipe it with a cloth soaked in water-diluted neutral detergent and wrung well, then wipe clean with a dry cloth.
- Since the System may deteriorate in quality, become damaged or get its paint peeled off, be careful about the following:

- DO NOT wipe it with a hard cloth.
- DO NOT wipe it forcefully.
- DO NOT wipe it with thinner or benzene.
- DO NOT apply any volatile substance such as insecticides to it.
- DO NOT allow any rubber or plastic to remain in contact for a long time.

To remove the speaker grilles:

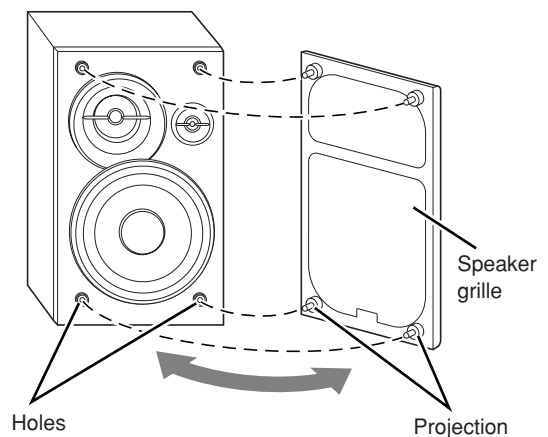

OPTICAL DIGITAL OUT Signals

DIGITAL AUDIO OUTPUT Playback disc	Output Signals		
	STREAM/PCM	DOLBY DIGITAL/PCM	PCM ONLY
DVD Video			
with 48 kHz, 16/20/24 bit Linear PCM	48 kHz, 16 bit Linear PCM*		
with 96 kHz, Linear PCM	48 kHz, 16 bit Linear PCM		
with Dolby Digital	Dolby Digital bitstream		48 kHz, 16 bit Linear PCM
with DTS	DTS bitstream	48 kHz, 16 bit Linear PCM	
DVD Audio			
with 48/96/192 kHz, 16/20/24 bit Linear PCM	48 kHz, 16 bit Linear PCM*		
with 44.1/88.2/176.4 kHz, 16/20/24 bit Linear PCM	44.1 kHz, 16 bit Linear PCM*		
with Dolby Digital	Dolby Digital bitstream		48 kHz, 16 bit Linear PCM
with DTS	DTS bitstream	48 kHz, 16 bit Linear PCM	
DVD-R/-RW in DVD-VR format			
with 48 kHz, 16/20/24 bit Linear PCM	48 kHz, 16 bit Linear PCM*		
with Dolby Digital	Dolby Digital bitstream		48 kHz, 16 bit Linear PCM
SVCD, VCD, CD	44.1 kHz, 16 bit Linear PCM/48 kHz, 16 bit Linear PCM		
CD with DTS	DTS bitstream	44.1 kHz, 16 bit Linear PCM	
MP3/WMA/MPEG-1/MPEG-2/DivX	32/44.1/48 kHz, 16 bit Linear PCM		
ASF	32 kHz, 16 bit Linear PCM		

* While playing some DVDs, digital signals may be emitted at 20 bits or 24 bits (at their original bit rate) through the DVD OPTICAL DIGITAL OUT terminal.

Operating JVC's TVs Using the Remote Control

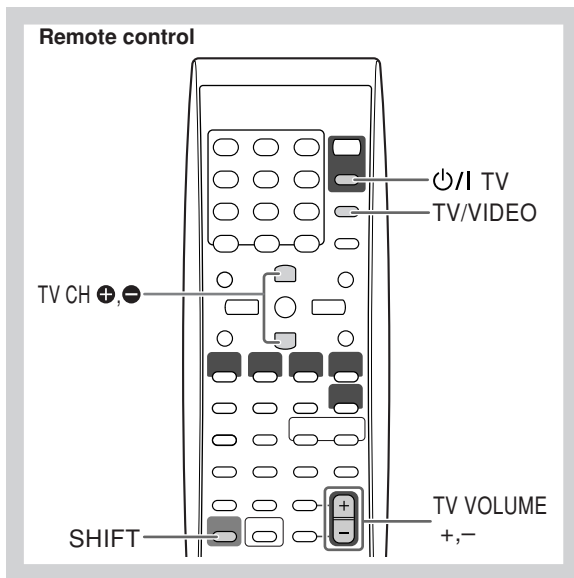

You can use the remote control to operate JVC's TVs.

O/I TV	Turn on/off TV.
While holding SHIFT, press...	
TV CH +, -	Change the channels.
TV VOLUME +, -	Adjust the volume.
TV/VIDEO	Change the input mode.

Specifications

Amplifier section—CA-UXG70

Output Power:	160 W (80 W+80 W) at 6 Ω (10% THD)
Audio Input	LINE IN: 500 mV/49 kΩ (at “L.IN LVL1”) 250 mV/49 kΩ (at “L.IN LVL2”) 125 mV/49 kΩ (at “L.IN LVL3”) MIC: 1.6 mV/10 kΩ
Audio Output	LINE OUT: 1.0 Vrms (3 kΩ) (at “L.OUT LVL1”) 500 mVrms (1.5 kΩ) (at “L.OUT LVL2”) SUBWOOFER OUT: 260 mVrms/3.9 kΩ HEADPHONES OUT: 17 mW/32 Ω
Digital output:	DVD OPTICAL DIGITAL OUT: -21 dBm to -15 dBm (660 nm ±30 nm)
USB input:	USB AUDIO
Video output:	Color system: NTSC or PAL(interlaced/progressive) VIDEO (composite): 1 V(p-p)/75 Ω S-VIDEO: Y (luminance) 1 V(p-p)/75 Ω C (chrominance, burst) NTSC 0.286 V(p-p)/75 Ω PAL 0.3 V(p-p)/75 Ω COMPONENT: (Y) 1 V(p-p)/75 Ω (P _B /P _R) 0.7 V(p-p)/75 Ω
Speaker impedance:	6 Ω – 16 Ω
Headphone impedance:	16 Ω – 1 kΩ

Tuner section

FM tuning range:	87.5 MHz – 108.0 MHz
AM (MW) tuning range:	531 kHz – 1 710 kHz (at 9 kHz intervals) 530 kHz – 1 710 kHz (at 10 kHz intervals) For Saudi Arabia only: 531 kHz – 1 602 kHz (at 9 kHz intervals) 530 kHz – 1 600 kHz (at 10 kHz intervals)

Tape section

Frequency response:	60 Hz – 14 000 Hz
Wow and flutter:	0.15 % (WRMS)

Disc player section

Region codes:	Middle East: 2 South East Asia: 3
Playable disc:	DVD Video/DVD Audio/CD/VCD/SVCD CD-R/CD-RW (CD/SVCD/VCD/MP3/ WMA/JPEG/MPEG-1/MPEG-2/ASF/DivX format) DVD-R/-RW (DVD-VR/DVD Video/MP3/ WMA/JPEG/MPEG-1/MPEG-2/ASF/DivX format) +R/+RW(DVD Video format) DVD-ROM (DVD Video format)
Dynamic range:	80 dB
Horizontal resolution:	500 lines
Wow and flutter:	Immeasurable

General

Power requirement:	AC 110 V/AC 127 V/AC 220 V/ AC 230 V-240 V ~ (adjustable with the voltage selector), 50 Hz/60 Hz
Power consumption:	95 W (at operation) 18 W (at standby) 3.9 W (at standby display OFF mode)
Dimensions (approx.):	175 mm x 250 mm x 411 mm (W/H/D)
Mass (approx.):	7.9 kg

Speakers—SP-UXG70

Speaker units:	Tweeter: 1.5 cm dome x 1 Squawker: 4 cm cone x 1 Woofers: 13.5 cm cone x 1
Impedance:	6 Ω
Dimensions (approx.):	166 mm x 250 mm x 232 mm (W/H/D)
Mass (approx.):	2.8 kg each

Supplied Accessories

See page 3.

Design and specifications are subject to change without notice.

- Manufactured under license from Dolby Laboratories. “Dolby”, “Pro Logic”, “MLP lossless”, and the double-D symbol are trademarks of Dolby Laboratories.
 - “DTS” and “DTS 2.0+ Digital Out” are registered trademarks of Digital Theater Systems, Inc.
 - “Official DivX® Certified product” “Plays all versions of DivX® video (including DivX® 6) with standard playback of DivX® media files” “DivX, DivX certified, and associated logos are trademarks of DivX, Inc. and are used under licence.”
 - USE OF THIS PRODUCT IN ANY MANNER THAT COMPLIES WITH THE MPEG-4 VISUAL STANDARD IS PROHIBITED, EXCEPT FOR USE BY A CONSUMER ENGAGING IN PERSONAL AND NON-COMMERCIAL ACTIVITIES.
 - This product incorporates copyright protection technology that is protected by U.S. patents and other intellectual property rights. Use of this copyright protection technology must be authorized by Macrovision, and is intended for home and other limited viewing uses only unless otherwise authorized by Macrovision. Reverse engineering or disassembly is prohibited.
- “CONSUMERS SHOULD NOTE THAT NOT ALL HIGH DEFINITION TELEVISION SETS ARE FULLY COMPATIBLE WITH THIS PRODUCT AND MAY CAUSE ARTIFACTS TO BE DISPLAYED IN THE PICTURE. IN CASE OF 525 OR 625 PROGRESSIVE SCAN PICTURE PROBLEMS, IT IS RECOMMENDED THAT THE USER SWITCH THE CONNECTION TO THE ‘STANDARD DEFINITION’ OUTPUT. IF THERE ARE QUESTIONS REGARDING OUR TV SET COMPATIBILITY WITH THIS MODEL 525p AND 625p DVD PLAYER, PLEASE CONTACT OUR CUSTOMER SERVICE CENTER.”

Parts Index

Remote control

Button	Page
⊕/⊖ AUDIO	21 7, 35
⊕/⊖ TV	22 43
■	12 10, 11, 19, 21, 28, 29, 30, 33
▶▶, ◀◀	14 9, 11
▶▶, ◀◀	34 9, 11, 21, 28
■	13 10, 19, 21, 27
▲, ▼, >, <, ENTER/SET	8 9, 11, 14, 15, 16, 18, 19, 21, 24 – 28, 33 – 36
C.VOICE	15 19
⤵ (One-Touch Replay)	32 19
Number buttons	1 9, 11, 19, 20, 25, 26, 33
3D PHONIC	16 14
AHB PRO	17 13
ANGLE	6 18
AUDIO/MPX	16 17
A.STANDBY	23 16
BASS/TREBLE	39 13
CANCEL	26 21, 33, 34, 35
CLOCK/TIMER	18 16, 34, 35
DIMMER	24 15
Disc tray selecting buttons	2 10
DISPLAY	26 16
DVD LEVEL	17 14
DVD/CD ▶	11 7, 10, 11, 21, 27, 30, 32, 33
ECHO	28 32
FADE MUTING	38 13
FM/PLAY MODE	36 8, 20, 21
FM/AM	10 7, 8, 9
GROUP/TITLE	32 10, 28
GROUP/TITLE SKIP	34 10, 28
KARAOKE	29 32
KEY ♭, #	8 32
LINE	31 7
LINE OUT LEVEL	5 14
MENU/PL	28 11, 26
ON SCREEN	29 24
PAGE	36 18
QP LINK	18 12
REPEAT	35 22, 28
REPEAT A-B	35 22
RESERVE	9 33
RETURN	7 11
SCAN MODE	3 15
SET UP	9 36
SHIFT	19 10, 11, 12, 14, 15, 16, 18, 19, 22, 28, 32, 33, 43
SLEEP	25 16
SLOW ♯, ♭	14 19
SOUND TURBO II	20 13
SUBTITLE	15 18
TAPE	33 7, 9
TOP MENU/PG	7 11, 26
TV CH ♯, ♭	8 43
TV VOLUME +, -	37 43
TV/VIDEO	24 43
USB	30 7, 12, 32
VFP	4 15
VOLUME +, -	37 7, 13
ZOOM	27 19, 28

Main unit

Button	Page
⊕/⊖ & STANDBY lamp	4 7, 8
■	16 8, 10, 22
Cassette holder	13 9, 29
DISC 1 - 5, PLAY, EJECT	10 10, 22
Display	3 6
DVD/CD ▶	7 7, 8, 10, 27, 30
DVD/CD ■	6 10, 27
FM/AM	8 8
LINE	19 7
LINE IN/OUT jacks	22 5
MIC jack	1 31, 32
MIC VOLUME	12 31, 32
PHONES	11 7
REC	9 29, 30
Remote sensor	2 5
SOUND TURBO II	5 13

TAPE	14 7, 9
UP ▶▶, DOWN ◀◀	15/17 8, 9, 11, 21
USB	18 12
USB AUDIO jack	21 12
VOLUME +, -	20 13, 31, 32

Remote control

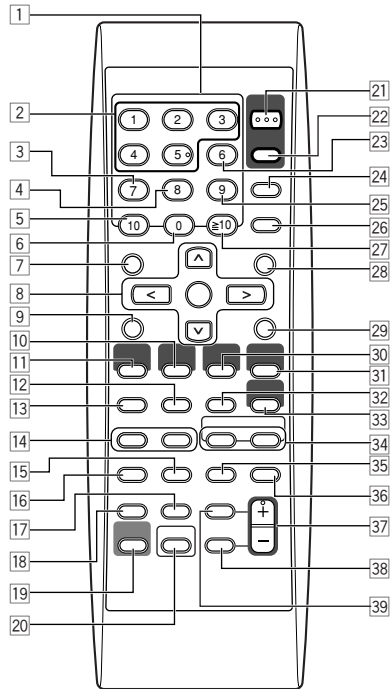

This remote control can also operate JVC's TVs (see page 43).

Main unit

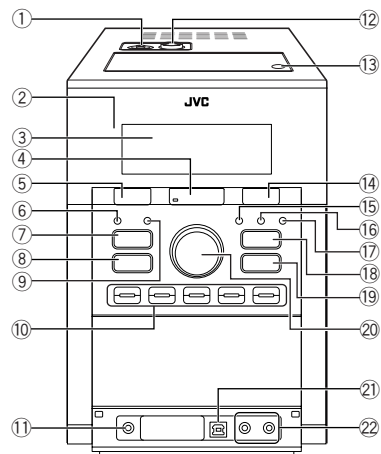

Mains (AC) Line Instruction (not applicable for Europe, U.S.A., Canada, Australia, and U.K.)

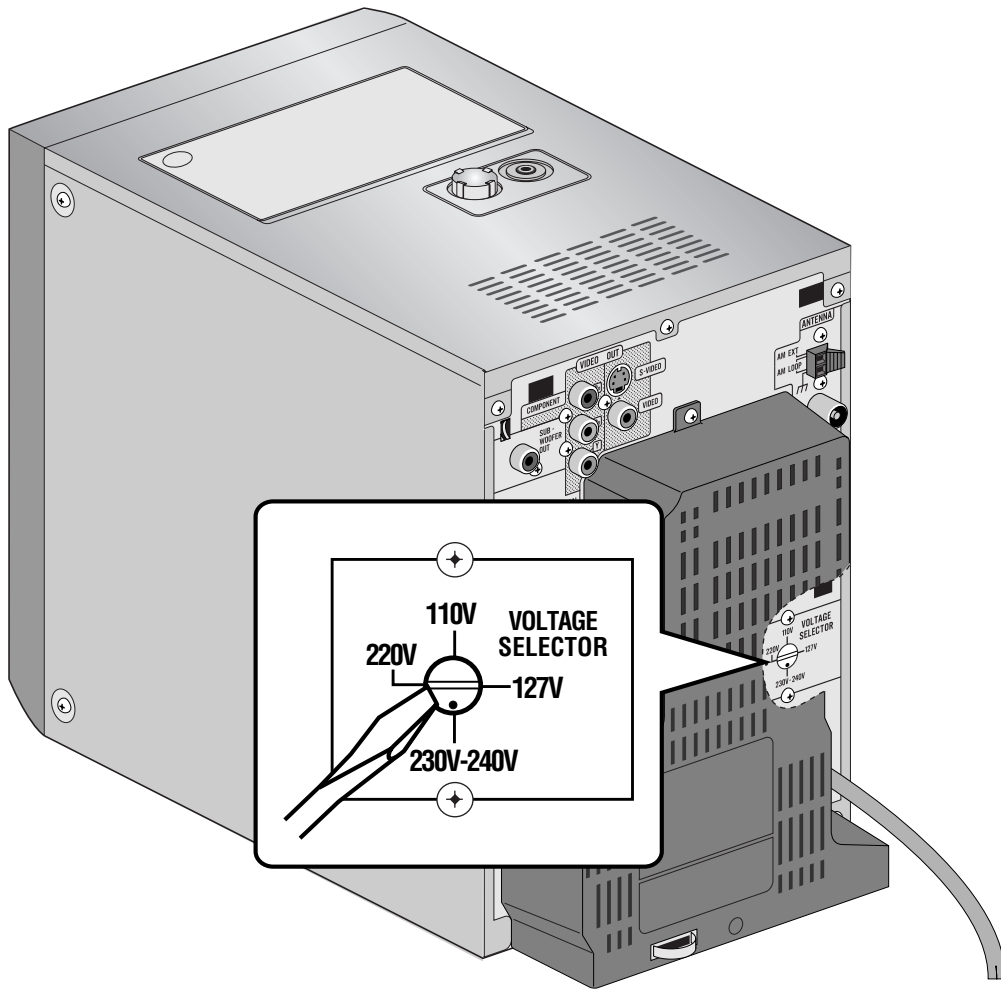

UX-G70 | MICRO COMPONENT SYSTEM

CAUTION for mains (AC) line
BEFORE PLUGGING IN, do check that your mains (AC) line voltage corresponds with the position of the voltage selector switch provided on the outside of this equipment and, if different, reset the voltage selector switch, to prevent from a damage or risk of fire/electric shock.

JVC